



f200

Car Camcorder

User Manual

f200 English User Manual Contents

About this Guide	3
FCC Statement.....	3
WEEE Notice.....	3
CE Regulatory Notice.....	4
Notes on Installation.....	4
Caution	4
1 Introduction	5
1.1 Features	5
1.2 Package Contents	5
1.3 Product Overview	6
2 Getting Started	7
2.1 Inserting the Memory Card	7
2.2 Installing in Vehicles	8
2.2.1 Mount to Windshield	8
2.2.2 Adjust Device Position.....	8
2.3 Connecting to Power	9
2.4 Powering the Device On / Off.....	10
2.4.1 Auto Power On/Off	10
2.4.2 Manual Power On/Off	10
2.5 Initial Settings	11
2.5.1 Set Automatic Recording.....	11
2.5.2 Set the Date and Time	11
3 Using the Car Recorder.....	12
3.1 Recording Videos	12
3.1.1 Record videos while driving	12

3.1.2	Record all other types of videos.....	12
3.1.3	Emergency Recording	13
3.1.4	The Recording Screen.....	14
3.1.5	Using the LED Light.....	15
3.1.6	Taking Snapshot	15
3.2	Playback Videos and Photos.....	16
3.2.1	Playing Videos	17
3.2.2	Viewing Photos	17
3.2.3	The Playback Screen.....	18
3.2.4	Deleting Files.....	19
4	Adjusting the Settings.....	20
4.1	Using the Menu	20
4.2	Menu Tree	21
5	Specifications	23

About this Guide

The content in this document is for information purpose and is subject to change without prior notice. We made every effort to ensure that this User Guide is accurate and complete. However, no liability is assumed for any errors and omissions that may have occurred. The manufacturer reserves the right to change the technical specifications without prior notice.

FCC Statement

This equipment has been tested and found to comply with the limits for a Class B digital device, pursuant to Part 15 of the FCC Rules. These limits are designed to provide reasonable protection against harmful interference in a residential installation. This equipment generates, uses and can radiate radio frequency energy and, if not installed and used in accordance with the instructions, may cause harmful interference to radio communications. However, there is no guarantee that interference will not occur in a particular installation. If this equipment does cause harmful interference to radio or television reception, which can be determined by turning the equipment off and on, the user is encouraged to try to correct the interference by one or more of the following measures:

- Reorient or relocate the receiving antenna.
- Increase the separation between the equipment and receiver.
- Connect the equipment into an outlet on a circuit different from that to which the receiver is connected.
- Consult the dealer or an experienced radio/TV technician for help.

This device complies with Part 15 of the FCC Rules. Operation is subject to the following two conditions: (1) This device may not cause harmful interference, and (2) this device must accept any interference received, including interference that may cause undesired operation.

FCC Caution: Any changes or modifications not expressly approved by the party responsible for compliance could void the user's authority to operate this equipment.

WEEE Notice

Disposal of Waste Electrical and Electronic Equipment and/or Battery by users in private households in the European Union



This symbol on the product or on the packaging indicates that this can not be disposed of as a household waste. You must dispose of your waste equipment and/or battery by handing it over to the applicable take-back scheme for the recycling of electrical and electronic equipment and/or battery. For more information about recycling of this equipment and/or battery, please contact your city office, the shop where you purchased the equipment or your household waste disposal service. The recycling of materials will help to conserve natural resources and ensure that it is recycled in a manner that protects human health and environment.

CE Regulatory Notice

This equipment complies with the requirements set out in the Council Directives on the Approximation of the Laws of the Member States relating Electromagnetic Compatibility (2004/108/EC); the Low Voltage Directive (2006/95/EC); the Restriction of The Use of Certain Hazardous Substances in Electrical And Electronic Equipment Directive (2002/95/EC), Turkish EEE Directive; the Commission Regulation (EC) No 1275/2008 implementing Directive 2005/32/EC of the European Parliament and of the Council with regard to eco-design requirements for standby and off mode electric power consumption of electrical and electronic household and office equipment, and the Directive 2009/125/EC of the European parliament and of the council establishing a framework for the setting of eco-design requirements for energy-related products.

Notes on Installation

1. Install the device near the rear-view mirror to obtain the best open-field view.
2. Make sure that the lens is within the wiping range of the windscreen wiper to ensure a clear view even when it rains.
3. Do not touch the lens with your fingers. Finger grease may be left on the lens and will result in unclear videos or snapshots. Clean the lens on a regular basis.
4. Do not install the device on a tinted window. Doing so may damage the tint film.
5. Make sure that the installation position is not hindered by the tinted window.

Caution

- ❖ Use the authorized charger only.
- ❖ Never disassemble by yourself.
- ❖ Never short-circuit the battery.
- ❖ Dispose of the battery properly.
- ❖ Exposing the battery to open flames can cause explosion.

1 Introduction

Thank you for purchasing this advanced Car Recorder. This device is specifically designed for real time video and audio recording when driving.

1.1 Features

- Full HD camera (1920x1080 @ 30fps)
- 2.4" LCD color screen
- Wide angle lens
- High power LED for low light environments
- Motion detection
- Automatic Emergency recording for collision detection
- Supports SDHC up to 32GB

1.2 Package Contents

The package contains the following items. In case there is any missing or damaged item, contact your dealer immediately.

Car Recorder



Bracket

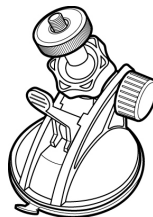

Car adapter

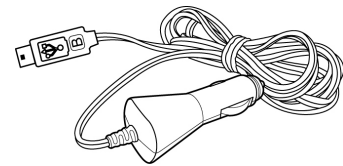

Quick start guide



Video cable

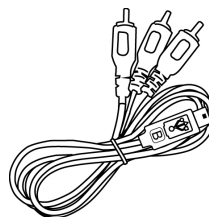

USB cable

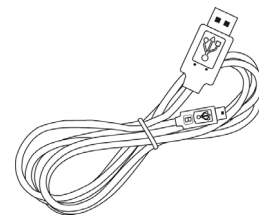

1.3 Product Overview

Top and Bottom Views

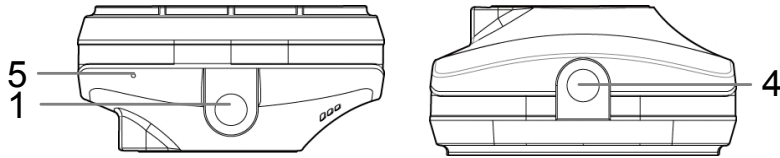

Front View

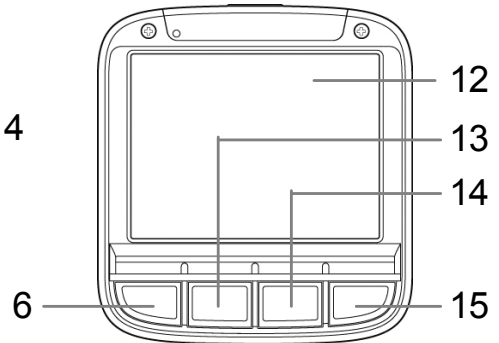

Side (Left and Right) Views

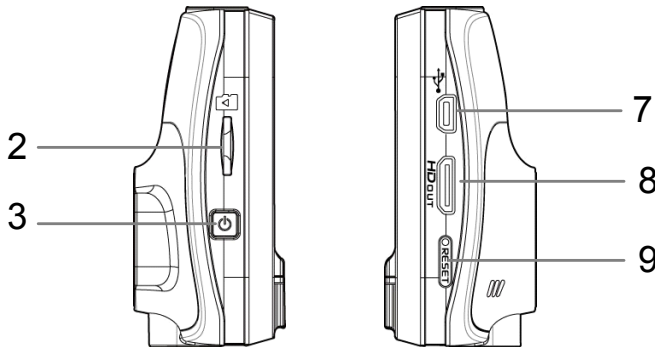

Rear View

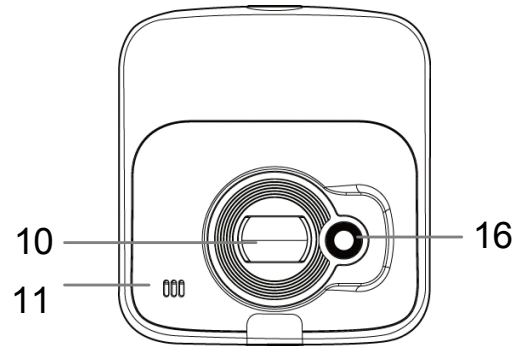

No.	Item
1	Bracket Socket
2	Memory Card Slot
3	Power Button
4	Bracket Socket
5	Microphone
6	Back Button (↶)
7	USB Connector
8	HDMI Connector

No.	Item
9	Reset Button
10	Wide Angle Lens
11	Speaker
12	LCD Panel
13	Up Button (▲)
14	Down Button (▼)
15	Enter Button (OK)
16	LED Light

Note: To operate the device, press the corresponding buttons (6, 13~15) according to guide icons shown the screen.

2 Getting Started

2.1 Inserting the Memory Card

Insert the memory card with the gold contacts facing the back of the device. Push the memory card until it clicks into place.

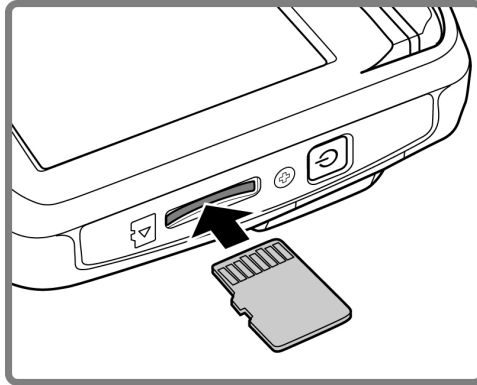

To remove the memory card

Push to eject the memory card out of the slot.

Note: Do not remove or insert the memory card when the device is turned on. This may damage the memory card.

2.2 Installing in Vehicles

2.2.1 Mount to Windshield

1. Attach the device to the bracket base. Turn and tighten the car holder and the bracket base to make sure the device is securely locked in place.

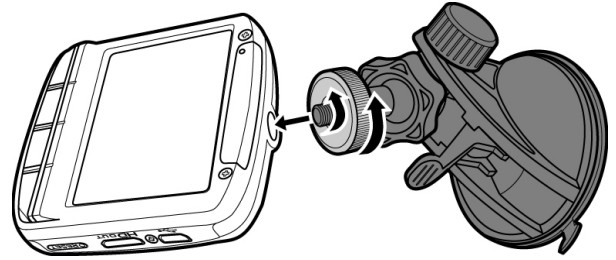

2. With the suction-cup laying flat, position the suction-cup on the windshield.
3. Hold the base firmly on the windshield and press down the clamp to mount the car holder to the windshield. Make sure the base is securely locked in place.

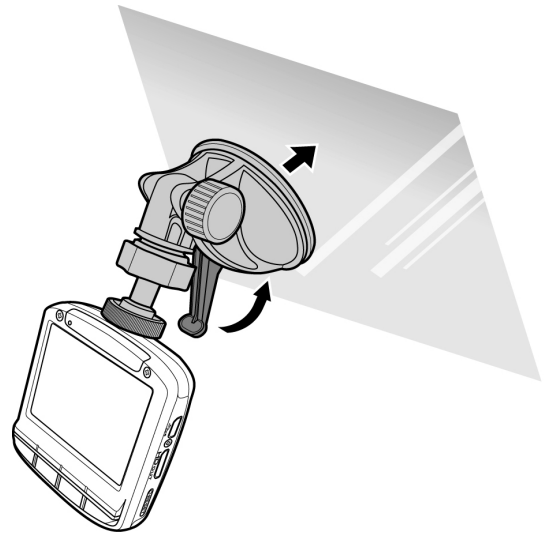

2.2.2 Adjust Device Position

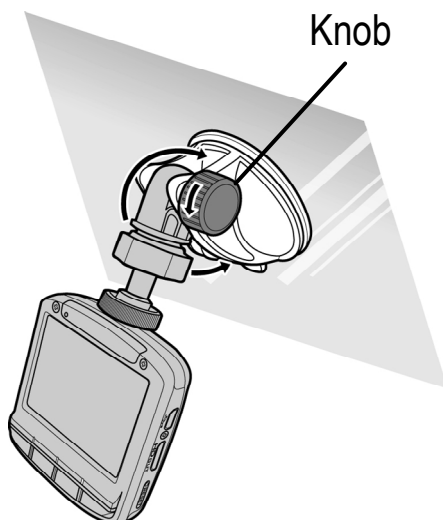

Rotate the knob to swivel the device vertically.

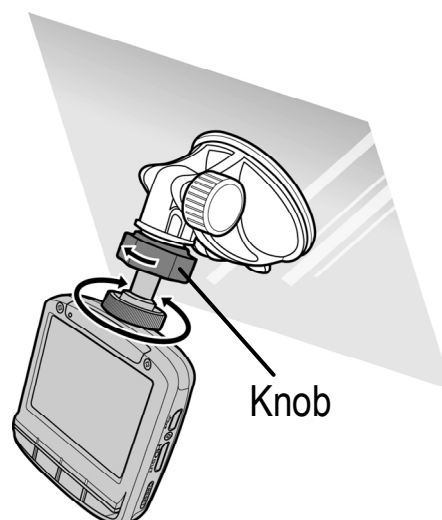

Rotate the knob to swivel the device horizontally up to 360°.

2.3 Connecting to Power

Use only the supplied car adapter to power up the device and charge the built-in battery.

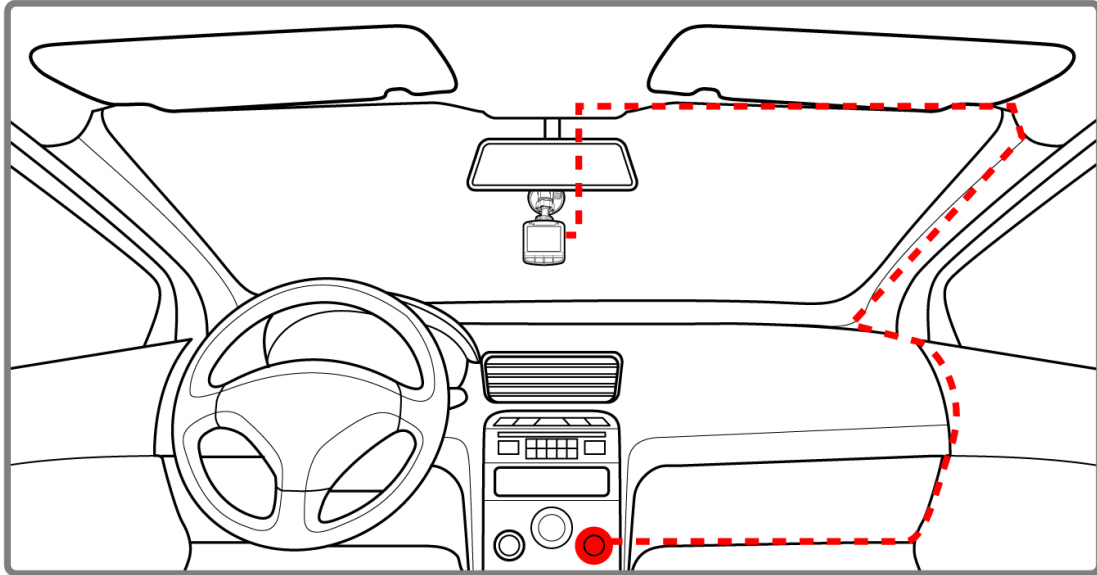

1. Connect one end of the car adapter to the USB connector of the device.
2. Plug the other end of the car charger to the cigarette lighter socket of your vehicle. Once the vehicle engine is started, the device automatically turns on.

Note:

The orange LED lights up while the battery is charging.

Please take note if the environment temperature reaches 45°C or above, the car adapter still can supply power to device, but it will not charge the Lithium-ion battery. This is the characteristic of Lithium-ion and is not a malfunction.

2.4 Powering the Device On / Off

2.4.1 Auto Power On/Off

Once the vehicle engine is started, the device automatically turns on. If the *Automatic Record* function is enabled, the recording will automatically start right after the device turns on.

See **Set Automatic Recording** on page 11.

Once the vehicle engine shuts down, the device automatically saves the recording and turns off the power within 10 seconds.

See **Delay Shutdown** on page 22.

2.4.2 Manual Power On/Off

To manually turn on the power, press the **POWER** button.

To turn off, press and hold the **POWER** button for at least 2 seconds.





2.5 Initial Settings

Before using the device, we recommend you to enable the *Automatic Record* function and set up the correct date and time.

2.5.1 Set Automatic Recording

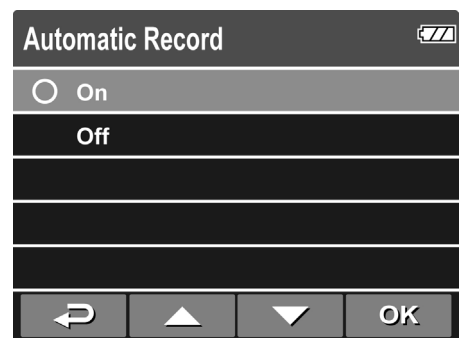

To enable the recording to start automatically after you turn on the power, do the following:

1. Press the  button to enter the OSD menu.
2. Press the  button to select **Automatic Record** and press the **OK** button.
3. Press the  button to select **On** and press the **OK** button.
4. Press the **BACK** button to exit the menu.



2.5.2 Set the Date and Time

To set the correct date and time, do the following:

1. Press the  button to enter the OSD menu.
2. Press the  button to select **Date / Time** and press the **OK** button.
3. Press the  button to adjust the value and press the **OK** button to move to another field.
4. Repeat step 3 until the date and time setting is complete.

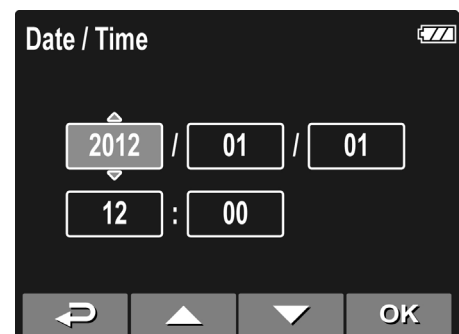

3 Using the Car Recorder

3.1 Recording Videos

3.1.1 Record videos while driving

When the vehicle engine starts up and the *Automatic Record* function is enabled, the device automatically turns on and starts recording.

Recording will automatically stop when the engine is switched off. Or, press the ▼ button to stop recording manually.

Note:

On some cars, the recording will continue when the engine is switched off.

If this happens, do one of the following:

- Manually turn off the cigarette lighter.
- Remove the car adapter from the cigarette lighter.

3.1.2 Record all other types of videos

1. Press the **OK** button to start recording.
2. Press the ▼ button to stop recording.

Note:

One video file is saved for every 3 or 5 minutes of recording. See *Using the Menu* 在第 20 頁.

The device saves the recording in the memory card. If the memory card capacity is full, the oldest file in the memory card is overwritten.

3.1.3 Emergency Recording

During video recording, press the **OK** button to continuously record the video in one file until the memory card storage is full or the recording is manually stopped.

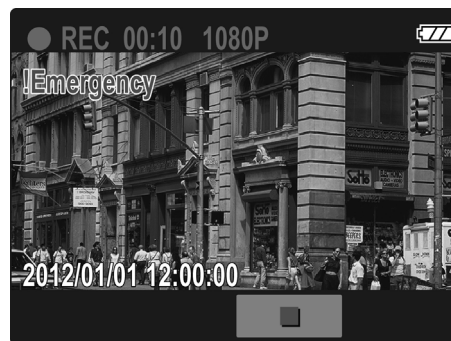

To stop the recording, press the **▼** button.



Note: If the *Collision Detection* function is enabled and a collision is detected, the device will automatically trigger the emergency recording. See *Using the Menu* 在第 20 頁.

3.1.4 The Recording Screen







No.	Item	Description
1	Duration	Indicates the recording duration.
2	Date and time	Indicates the current recording date and time.
3	Guide icon (Menu)	Press the  button to enter the OSD menu.
4	Battery	Indicates the remaining battery power.
5	Guide icon (Stop)	Press the  button to stop the recording.
6	Guide icon (Emergency)	Press the OK button to continuously record the video in one file until the recording is manually stopped.
7	Guide icon (Playback)	Press the  button to switch to Playback mode.

3.1.5 Using the LED Light

You can use the LED light to provide extra light when the lighting is insufficient.

To enable the LED light, do the following:

1. Press the  button to enter the OSD menu.
2. Press the  button to select **Auxiliary Light** and press the **OK** button.
3. Press the  button to select **On** and press the **OK** button.
4. Press the  button to exit the menu.

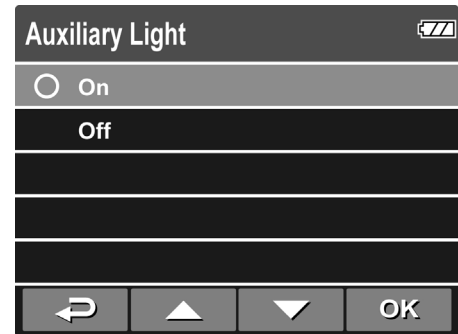

Note:

Turn off LED lights when the battery is low.

When using LED lights for a long time, it may become hot. Take care not to touch the hot LED lights.

3.1.6 Taking Snapshot

You can also use this device to take snapshots of the current scene.

From the standby screen, press the  button to take a snapshot.

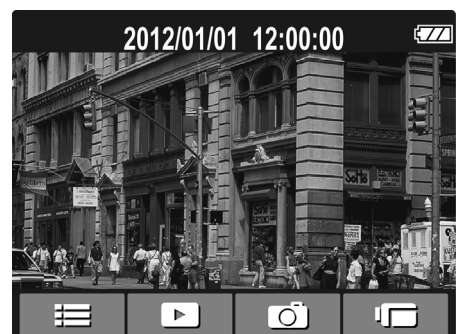

Note: If recording is in progress, press the  button to stop the recording.

3.2 Playback Videos and Photos

1. If recording is in progress, press the ▼ button to stop recording. The standby screen is displayed.
2. Press the ↶ button to enter the OSD menu.
3. Press the ▲/▼ button to select the file category that you want to browse and press the OK button.
4. Press the ▲/▼ button to view the next or the previous file and press the OK button to view the file in full screen.

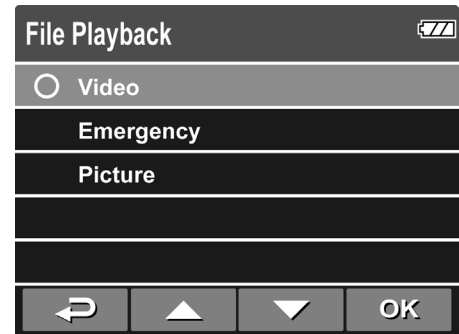

Note: From the standby screen, you can directly enter Playback mode by pressing ▲ button. The last recorded video is displayed on the screen.

3.2.1 Playing Videos

To play videos, do the following:

1. If recording is in progress, press the ▼ button to stop recording.
2. Press the ↶ button to enter the OSD menu.
3. Press the ▲/▼ button to select **File Playback** and press the **OK** button.
4. Press the ▲/▼ button to select **Video** or **Emergency** and press the **OK** button.
5. Press the ▲/▼ button to browse for the desired video file and press the **OK** button to play the video.
6. Press the **OK** button to pause the playback. Press it again to resume.



3.2.2 Viewing Photos

To view photos, do the following:

1. If recording is in progress, press the ▼ button to stop recording.
2. Press the ↶ button to enter the OSD menu.
3. Press the ▲/▼ button to select **File Playback** and press the **OK** button.
4. Press the ▲/▼ button to select **Picture** and press the **OK** button.
5. Press the ▲/▼ button to browse for the desired photo file and press the **OK** button to view the file in full screen.





3.2.3 The Playback Screen

Video Playback Screen

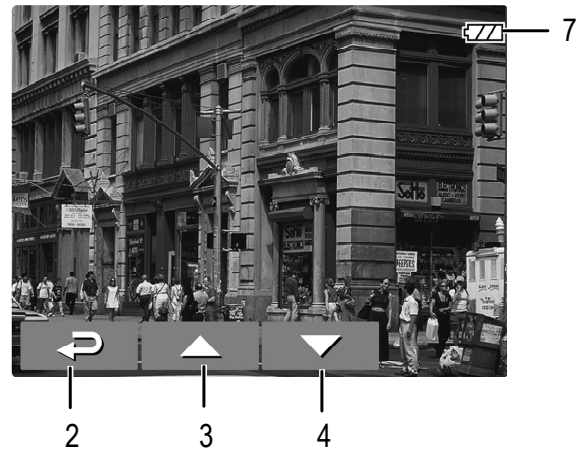

Photo Playback Screen



No.	Item	Description
1	Date and time	Indicates the recorded date and time.
2	Guide icon (Back)	Press the  button to return to file selection display.
3	Guide icon (Previous)	Press the  button to view the previous video/photo.
4	Guide icon (Next)	Press the  button to view the next video/photo.
5	Guide icon (Pause)	Press the  button to pause the video playback.
6	Duration	Indicates the elapse time.
7	Battery	Indicates the remaining battery power.

3.2.4 Deleting Files

To delete file(s), do the following:

1. If recording is in progress, press the ▼ button to stop recording.
2. Press the ↶ button to enter the OSD menu.
3. Press the ▲/▼ button to select **File Deletion** and press the **OK** button.
4. Press the ▲/▼ button to select the file category and press the **OK** button.



5. Press the ▲/▼ button to select the file that you want to delete and press the **OK** button to enter the Delete menu.

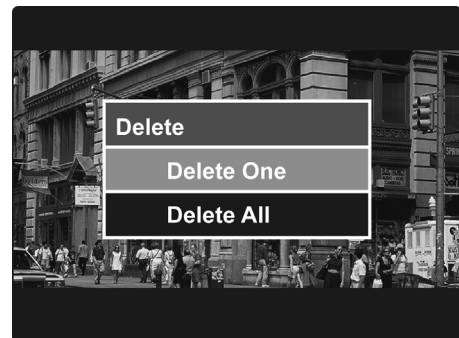

6. Press the ▲/▼ button to select an option.

Item	Description
Delete One	Delete the current file.
Delete All	Delete all files.

7. Press the **OK** button to confirm delete.

Note: Deleted files cannot be recovered. Ensure the files have backup before deletion.

4 Adjusting the Settings

4.1 Using the Menu

You can customize the video recording and other general settings via the on-screen display (OSD) menus.

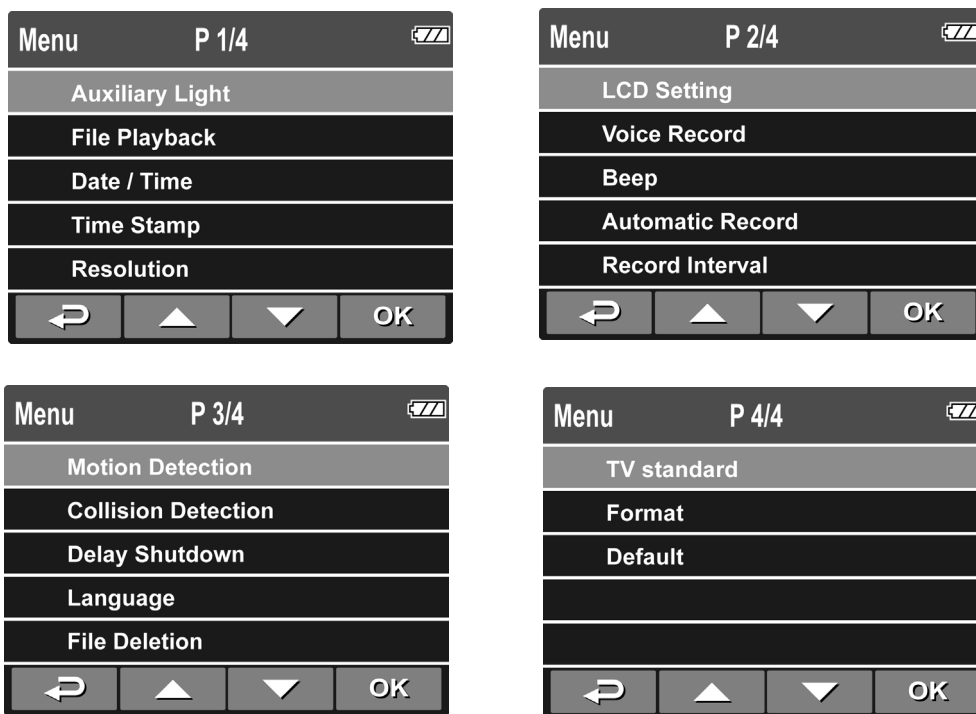

1. If recording is in progress, press the **Record** button to stop recording.
2. Press the button to open the OSD menu.
3. Press the button to select a menu option and press the **OK** button to enter the selected menu.
4. Press the button to select the desired setting and press the **OK** button to confirm the setting.
5. Press the button to exit the menu.

4.2 Menu Tree

Refer to the below table for details on menu items and available menu options.

Menu option	Description	Available option
Auxiliary Light	Enable/Disable the LED light.	On / Off
File Playback	Select the file category that you want to view.	Video / Emergency / Picture
Date / Time	Set the date and time.	
Time Stamp	Enable/Disable the date stamp.	On / Off
Resolution	Set the video resolution.	1080P(1920x1080) / 720P(1280x720)
LCD Setting	Set the duration for the display to automatically turn off right after video recording starts.	On / Turn Off After 30 Sec. / Turn Off After 3 min. / Off
Voice Record	Enable/Disable the voice recording.	On / Off
Beep	Enable/Disable the beep.	On / Off
Automatic Record	Enable/Disable the device to automatically record video after the device is turned on.	On / Off
Record Interval	Set the recording duration for each recorded video file.	3 mins / 5 mins
Motion Detection	Enable/Disable the motion detection. If this function is enabled and the device detects any object movement, it will automatically start the recording.	On / Off

Menu option	Description	Available option
Collision Detection	Enable/Disable the collision detection. If this function is enabled and any collision is detected, the device will automatically trigger the emergency recording.	High Sensitivity / Normal Sensitivity / Low Sensitivity / off
Delay Shutdown	Set the delay duration before turning off the power.	10 Sec. / Off
Language	Set the on-screen display menu language.	
File Deletion	Delete the file(s).	Video / Emergency / Picture
TV standard	Set the TV type based on your local region.	NTSC / PAL
Format	Format the memory card.	Yes / No
Default	Reset all settings to factory default settings.	Yes / No

5 Specifications

Item	Description
Image sensor	1/3.2" CMOS sensor
Effective pixels	2592 (H) x 1944 (V)
Storage media	Support Micro SDHC, up to 32GB class 4 or above
LCD display	2.4" LCD color TFT (112K pixels)
Lens	Wide Angle Fixed Focus lens F2.4, f=3.0mm
Focus range	1.5m~Infinity
Movie Clip	Resolution: Full HD (1920 x 1080), 30fps HD (1280 x 720), 30fps
	Format: .mov
Still image (Snapshot)	Resolution: 5M (2592 x 1944)
	Format: DCF (JPEG, Exif: 2.2)
Shutter	Electronic shutter Auto:1/2 ~1/2000 sec.
G-Sensor	3-Axis G-Force sensor
ISO	Auto
White Balance	Auto
Assist Lamp	Yes
Microphone	Yes
Speaker	Yes

Item	Description
Interface	Mini USB, Mini C Type HDMI
Battery	Built-in 470mAH Li-polymer rechargeable
Operating Temperature	-10° ~ 60° C
Operating Humidity	20 ~ 70% RH
Storage Temperature	-20° ~ 80° C
Dimensions	67.8 x 62 x 30 mm
Weight	Approx. 85g

Copyright © 2013

All rights reserved.

All other marks, products or company names mentioned in this guide are trademarks of their respective companies.