

**HDT-H12
USER'S MANUAL**

Table of Contents

▶ <i>General</i>	<i>6</i>
▶ <i>Getting Started</i>	<i>12</i>
▶ <i>Basic Functions</i>	<i>18</i>
▶ <i>Call Lists</i>	<i>24</i>
▶ <i>Handset & Base Setting</i>	<i>32</i>
▶ <i>Extra Setting</i>	<i>42</i>
▶ <i>Menu Structure Map</i>	<i>46</i>
▶ <i>Troubleshooting</i>	<i>47</i>
▶ <i>Additional Information</i>	<i>48</i>

HYUNDAI

Introduction

Congratulations on buying this cordless phone. Your new DECT (Digital Enhanced Cordless Telephone) is designed with advanced features. Similarly to GSM, this technology allows you to get the benefits of the digital wireless communication systems, which are better protected against interferences, tapping and intrusions. Moreover, there are a lot of features you will enjoy, the most important ones are:

- Ease of use - the large LCD display and the "cellular feeling" software commands make the equipment user friendly, even by non expert people.
- Color LCD display - customizable with wallpapers and backgrounds.
- Alphanumeric phonebook - allows you to call your frequently used numbers (up to 250). It saves your time and money, because you can quickly call them and reduce the risk of wrong dialling.
- SIM card reading - you can copy the phonebook from your mobile phone into the phonebook of your cordless phone. This let you save time and reduce dialling mistakes by using the same phonebook of your mobile phone.
- Handsfree operation - the speakerphone of your handset allows you to enjoy the handsfree conversations. Just put the handset on your desk and talk in total freedom.
- 12 polyphonic rings tones with sleep mode - the ring volume automatically switches to the minimum volume in order not to disturb you in night time. Very convenient if your phone is located near a bedroom.
- Caller Display - to see who is calling and keep track of unanswered calls.
- "Organizer" functions - your phone can be used as a convenient alarm, also as a calculator.
- Personal cordless network - you can create your personal cordless phone network by connecting up to 5 (optional) handsets to your base. Moreover, every handset can access up to 4 (optional) base units in order to extend the total wireless coverage.

...and many others!

✍ Note: The manufacturer is committed to continuous quality improve, for this reason specifications and features may vary without prior notice.

✍ Services such as Caller Display are available only if provided by your local telephone network.

This product is suitable for use in the Public Analogue Network (PSTN)



If you subscribe to a DSL service

Please attach a noise filter (contact your DSL provider) to the telephone line between the base unit and the telephone line jack in the event of the following:

- Noise is heard during conversations.
- Caller ID features do not function properly.

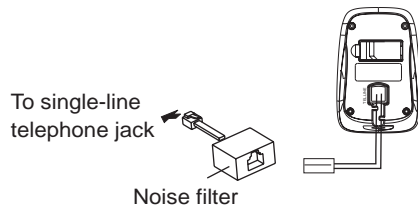

Warning Notes

! Your DECT cordless telephone has been carefully designed to give you years of safe, reliable performance. As with all electrical equipment, however, there are a few basic precautions you should take to avoid hurting yourself or damaging the unit:

- Read the instructions in this handbook carefully. Be sure to save it for future reference.
- Read and follow all warning and instruction labels on the equipment itself.
- Be sure to use only the supplied AC adapter and that your power source matches the rating listed for it. If you are not sure, check with your dealer or with your local power company.
- Avoid strong shocks. Don't use the AC adaptor if it has received any hard knocks or looks damaged in any way; immediately contact an authorised service centre.
- Grasp your handset firmly. Otherwise it may fall and be damaged.
- Do not operate in an explosive atmosphere.
- Do not use the phone near water, or spill liquid of any kind on it. If you think that some liquid is penetrated into the phone, immediately unplug it, dry it by a soft and clean cloth and contact your dealer.
- Respect the environment conditions. All the parts of this equipment are designed for indoor use only. Never expose them to extremely hot or cold temperature. Don't expose the cordless telephone to excessive vibrations as well as dusty or rainy places.
- Never try to disassemble or service the equipment by yourself (aside from the routine maintenance described in this handbook). It will immediately void the warranty and you may cause damage requiring extensive repair work. Always contact your local dealer for assistance.
- Handle the batteries properly. Particularly, strictly follow the directions stated in the handbook.
- Never use the phone with non suitable batteries and charge them only with the supplied base. The use of any non genuine parts can create hazards, electric shocks and other risks. Moreover it will void the warranty.
- In case of problems, please refer to this user's manual or contact your dealer and/or the nearest official service centre. Every service operation not provided by official service centres will void the warranty.
- Use always good sense! Don't go on with any operations if you are not sure what you are really doing. In case of doubts please contact your dealer.
- This equipment is not able to make calls (including emergency ones) when the mains power fails, when the handset batteries need to be charged (or are faulty), when the keypad is locked.
- This product must not be used near emergency medical equipment or by people with medical equipment fitted (e.g. pacemakers). Moreover, the radio signals between the handset and the base may interfere with hearing aids causing strong noise.

Table of Contents

General	
Feature List	6
The Unit Layout	8
Key Functions	9
Handset Display	11

Getting Started

Package Contents	12
Connection	12
Installing the Batteries	13
Charging the Handset Batteries	13
Turning Handset On/Off	14
Registering a New Handset	14
Deactivating a Handset	15
Choosing the Dial Mode	16
Setting Date & Time	16

Basic Functions

Making a Call	18
Receiving a Call	19
Adjusting Voice Volume	19
Muting a Call	19
Using Speakerphone	20
Redialling Last Dialed Number	20
Flash Signal	20
Using a Pause	20
Out of Range Indication	21
Locking the Handset Keypad	21
Paging	21
Temporary Tone Dial Switchover	22

Technical Specifications

Frequency Range	1.88-1.90 GHz
Channels	120 duplex channels
RF Carrier Power	< 250 mW (24 dBm)
Modulation	GFSK
Frequency Stability	< \pm 50 KHz
Operation Time	Standby: up to 100 hours; talk time: up to 12 hours
Charging time	15 hours
Ambient temperature	Normal: 15°C ~ 35°C, Extreme: 0°C ~ 40°C
Humidity	0% ~ 90%
Weight (grams)	Base unit: 99; handset: 121
Size (mm)	Handset: 123 x 47 x 28; Base: 51 x 116 x 77
Power supply	Base input: 9 V _{dc} , 300mA; Handset input: Li-ion: 3.7V, 550 mA

HYUNDAI DISTRIBUTOR'S WARRANTY (APPLICABLE FOR SINGAPORE ONLY)

Alcom Electronics Pte Ltd (Distributor) guarantees to you, the original purchaser, the Digital Cordless Telephone and accessories (the "Products") which you have purchased from an authorized reseller, to be in conformance with the applicable specifications current at the time of manufacture for a term of 12 months (Warranty Term) from date of purchase of the Product(s). You must inform Distributor of the lack of conformity to the applicable specifications of any of the Products within a period of two (2) months from the date on which you detect a defect in material, workmanship or lack of conformity and in any event within a term not to exceed the Warranty Term, and must immediately submit the Product for service to Distributor's Repair or Service Centre.

During the Warranty term, Distributor will, at its discretion and without extra charge, as your exclusive remedy, repair or replace your Product which does not comply with this warranty; or failing this, to reimburse the price of the Product but reduced to take into account the use you have had of the Product since it was delivered. This warranty will expire at the end of the Warranty Term.

WARRANTY SERVICE?

In order to be eligible to receive warranty service, you must present your receipt of purchase or a comparable substitute proof of purchase bearing the date of purchase. The digital cordless telephone should also clearly display the original serial number.

For details, please contact:

Alcom Electronics Pte Ltd
37, Kallang Pudding Road, #05-08, Blk-B Tong Lee Building, Singapore 349315
Ph: (65) 68412668 Fax: (65) 68412628 E-mail: support@alcom.com.sg
www.alcomonline.com

Troubleshooting

Symptom	Possible cause	Solution
The handset doesn't switch on.	Batteries discharged or not (well) installed.	Try charging the handset for few minutes, then remove it from the base. If it still doesn't switch on, check the battery installation.
	Batteries damaged or not suitable.	If you already did the above stated operation unsuccessfully, try replacing the batteries.
	Faulty handset.	Contact an authorized service centre.
Handset works, but doesn't access the base unit.	No power connection in the base unit.	Check the connection of the AC power adaptor.
	Handset not registered to the base unit or lost registration.	Try registering the handset to the base.
Handset works and access the base unit, but no dial tone is heard.	Wrong connection of the phone line cord.	Check the connection of the line cord.
Handset works perfectly, but the numbers are not dialled to the line.	You have set the dual tone multi frequency system (DTMF), but your line doesn't support it.	Try selecting the pulse dial.
Handset works perfectly, but you hear a beep during the phone calls.	Batteries near to being fully discharged.	Check the battery charge and charge it if necessary.
Noise and audio interferences on your phone calls.	Handset too far from the base.	Get closer to the base unit. If you can access more base units, try selecting a closer one.
Handset works perfectly, but doesn't ring with incoming calls.	Ring volume level set to OFF.	Select another ring level.
Handset can only receive calls. Keypad locked.	You have activated the keypad lock function.	Try by keeping pressed the * key .
The phone doesn't dial certain numbers.	Outgoing calls barring function activated.	Check the call barring function and change it if necessary.
Phone doesn't work properly with some special services or if connected to an exchange extension (PABX).	Flash time not properly set.	Check the Flash time and set it properly.
Battery duty is very low.	Charging contacts not clean.	Clean them.
	Battery life reached the end.	Replace the batteries.
Logical malfunctioning in the handset or base unit.	AC power supply noise or electrostatic spikes could temporarily altered the internal memory.	Try resetting the handset or the base.
	Faulty handset or base unit.	Contact an authorized service centre.

Intercom	22
Call Transfer between Handsets	23
Setting Up a Three-way Conference Call	23

Call Lists

Incoming Calls	24
Reviewing/Dialling a Number in Incoming Calls List	24
Using Incoming Calls Options	25
Outgoing Calls	25
Phonebook	26
Storing Phonebook Entries	26
Character Map	27
Reviewing/Dialling a Number in Phonebook	28
Using Phonebook Entries Options	29
SIM Card Reading	29
Country Code	31
Caller ID on Call Waiting	31

Handset & Base Setting

Selecting Ring Type & Volume	32
Setting Key Tone	32
Changing Handset & Base PIN Code	33
Changing Handset PIN	33
Changing Base PIN	34
Reset the Handset and the Base PIN	34
Base Selection	35
Resetting the Handset or the Base	36
Resetting the Handset	36
Resetting the Base	36
Setting Auto Answer	37
Setting Display	38
Adjusting the Display Contrast	38
Selecting the Wallpaper	38

Selecting the Windows Style 39
 Setting a Handset name 39
 Selecting a Language 39
 Changing Flash Time 40
 Setting Call Barring 41

Extra Setting

Alarm 42
 Setting Sleep Mode 43
 Game-Sudoku 43
 Calculator 44
 Setting Access Code 45

Menu Structure Map 46

Troubleshooting 47

Additional Information

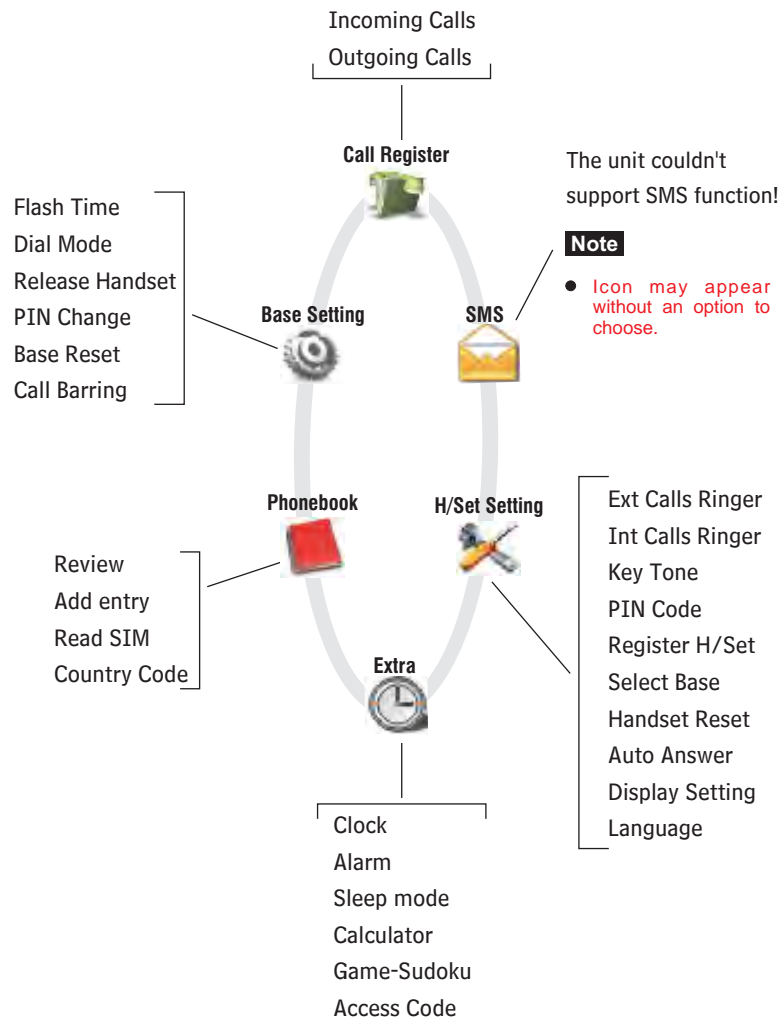

Technical Specifications 48

Menu Structure Map



Setting Access Code

Some telephone systems, such as PABX (Private Automatic Branch of eXchange) or KTS (Key Telephone Systems), require an access code (e.g. 9 or 0) to access an external line and listen for the outside dial tone before dialling the outside number. You can set your phone in order to automatically insert one-digit access code when you use a phone number from the received calls list. For details about the received calls list, see the "Incoming calls".

- 1 Press **MENU** key to display the main menu items.
- 2 Press repeatedly the  key to choose , then press the **SELECT** key.
- 3 Press the **▲** or **▼** key to choose **Access Code**, then press the **SELECT** key.
- 4 Use the **◀** or **▶** key to select the access code from 0 to 9.
- 5 Press the **SELECT** key to save the setting.

Feature List

Cordless Phone

- 1.8G DECT technology with GAP
- 1.5 inches Large LCD display with 128 x 128 dots matrix (5lines) and 65K color
- Phonebook with up to 250 entries
- Outgoing calls list with up to 20 entries
- Up to 5 handsets for optional for one base
- Up to 4 bases for optional for one handset
- 12 Polyphonic ringtones and 3 ring melodies
- 4 ringer volume levels selectable
- Three-way conference call
- Call transfer
- Vip ringer
- Voice volume adjustable (5 levels)
- 7 languages selectable
- LCD contrast adjustable (11 levels)
- Flash time selectable
- Key tone ON/OFF selectable
- Auto answer ON/OFF selectable
- 10 Wallpapers selectable
- 8 Window Styles selectable
- Dialling mode selectable
- PABX Access code setting
- Handset Name setting
- Talking time display
- Internal call
- PIN protection
- Call barring
- Handsfree
- Mute function
- Real clock
- Keypad lock
- Redial, Flash, Pause
- Preparation dialling
- Sleep mode selection
- Alarm
- Calculator



- Game-Sudoku
- Illuminated keypad
- SIM card reader

Caller ID and SMS

- FSK / DTMF Caller ID
- TYPE1/2 Caller ID
- Incoming calls list with up to 30 entries
- Call back/Add to phonebook/Delete
- New incoming call indicator
- Private/Out of area

Calculator

Using this feature, you can use the phone as a calculator. You can perform calculations including addition, subtraction, multiplication and division on your phone.



- 1 Press **MENU** key to display the main menu items.
- 2 Press repeatedly the  key to choose , then press the **SELECT** key.
- 3 Press the **▲** or **▼** key to choose **Calculator**, then press the **SELECT** key.
- 4 Enter the first number (operand) using the numeric keys.
- 5 To select the operation for four calculation, press the **◀** or **▶** keys to choose the required arithmetic symbol appears:
+(addition), -(subtraction), *(multiplication), /(division.)
- 6 Enter the second number (second operand) using the numeric keys.
- 7 To get the result, press the **SELECT** key.

Notes

- To erase any mistake and clear the display, press the **CLEAR** key.
- To insert a decimal point, press ***** key or use **◀** or **▶** key to select the "." symbol.

Setting Sleep Mode

This feature allows you to not be disturbed by the ring sound at night. If the sleep mode is activated, the ring volume automatically switches to minimum volume level during time from 23:00 to 6:59.



- 1 Press **MENU** key to display the main menu items.
- 2 Press repeatedly the  key to choose  ^{Extra}, then press the **SELECT** key.
- 3 Press the **▲** or **▼** key to choose **Sleep mode**.
- 4 Press the **SELECT** key to turn on this feature. You can see the  icon appears at the right of the **Sleep mode** item.

Note

- In Standby mode, the  icon will appear at the right of the date if you have activated the feature.

Game-Sudoku

There is a game for you playing in the leisure time. The game's instruction: You should input digits (1 to 9) in the empty grids one at a time in order to fill in the whole layout, but it does not allow to input the same digit in one row or one line.

- 1 Press **MENU** key to display the main menu items.
- 2 Press repeatedly the  key to choose  ^{Extra}, then press the **SELECT** key.
- 3 Press the **▲** or **▼** key to choose **Game-Sudoku**, then press the **SELECT** key to start playing.

Note

- During playing the game, press * key for help, and press the * key again to return to the game.

The Unit Layout

Handset

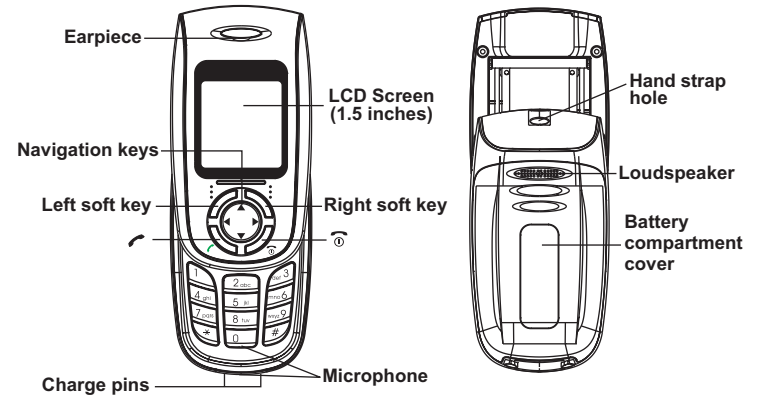

Base

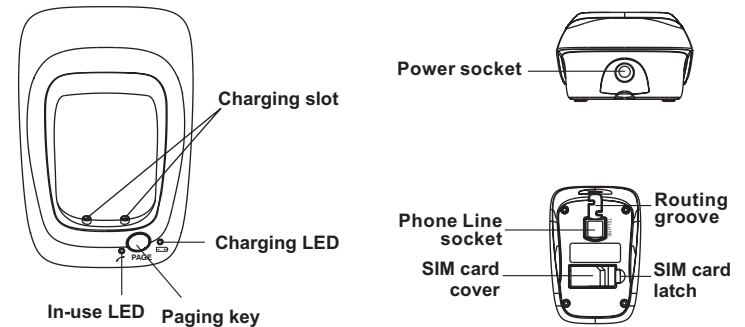

Key Functions



To enter # or switch between upper case and lower case in English mode.



Press and hold to turn on/off keypad lock function.



Perform the functions indicated by the text immediately over them (on the bottom line of the display) which changes time by time.



Press to turn the phone on. If held pressed, turns the phone off. In menu mode, briefly press it to cancel your input and return to standby mode. During a call, briefly press it to end the call.



Makes telephone calls and answers them. If pressed during a call, activates the speakerphone for handsfree operation.



To locate the registered handset easily or register a new handset.

To scroll up/down when browsing selections.
To move the cursor to left/right when editing a record and use the ◀ button to delete the wrong digits or characters.

In standby mode:

- Left: One-touch for internal call.
- Right: One-touch for incoming call list.
- Up: One-touch for outgoing call list.
- Down: One-touch for Phonebook.

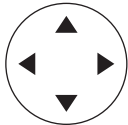

In use mode:

- Left: One-touch for internal call.
- Right: Mute/Unmute the microphone.
- Up: Increase receiver volume.
- Down: Decrease receiver volume.

Alarm

This option allows you to set one alarm that can ring once.

Activating the Alarm Feature

- 1 Press **MENU** key to display the main menu items.
- 2 Press repeatedly the key to choose , then press the **SELECT** key.
- 3 Press the ▲ or ▼ key to choose **Alarm**, then press the **SELECT** key.
- 4 You are now on the time field. Set the time with hh:mm format by using the numeric keys.
- 5 Press the **SELECT** key to save the alarm time setting and enter the alarm ring type setting.
- 6 Press the ◀ or ▶ key to select the ring type for the alarm.
- 7 Press the **SELECT** key to save the setting and exit to the previous menu. You can see the icon ✓ appears at the right of the **Alarm** item.
- 8 When the alarm sounds, press any key to switch it off.

Deactivating the Alarm Feature



- 1 Perform steps 1 to 3 of the last paragraph. Then the ✓ icon will disappear.

Notes



- At step 3 you need to enter the hour in 24-hour format.
- In Standby mode, the ▲ icon will appear at the left of the time if you have activated the feature.

Setting Call Barring

You can set the phone to restrict numbers that can be dialed. Calls beginning with the numbers you specify using this menu can not be dialed. You can set up to 5 different restricted numbers containing up to 5 digits each.

- 1 Press **MENU** key to display the main menu items.
- 2 Press the navigation keys  to choose  Base Setting, then press the **SELECT** key.
- 3 The handset asks you to enter the current base PIN code (the default PIN is **1590**). Use the numeric keys to enter and press **SELECT** key.
- 4 Press the **SELECT** key to access **Call Barring**, then press the **SELECT** key.
- 5 Press the ◀ or ▶ key to choose the barring memory location.
- 6 Enter the number you want to restrict (up to 5 digits) and then press the **SELECT** key.
- 7 Enter your desired handset number which you want to restrict the stored barring number. Then press the **SELECT** key to save the setting.

Display keys

In different mode, press left  and right  buttons to initiate the corresponding functions shown on the LCD display.

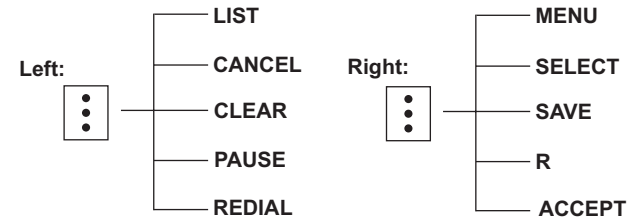















- LIST** To access the Incoming Calls list or the Outgoing Calls list.
- CANCEL** To cancel settings and go to the previous menu.
- CLEAR** To clear digits or characters when you store phone numbers.
- PAUSE** To insert a pause during dialling a number.
- REDIAL** To redial the last outgoing number.
- SELECT** To confirm.
- SAVE** In standby mode, to save numbers to Phonebook.
- R** To switch between 2 callers (call waiting) or get a new dial tone for another call.
- ACCEPT** To answer a call.
- MENU** To enter main menu. The LCD display shows as below:





Handset Display

Information on the LCD display:

When the phone is in different mode, the LCD display shows different icons.



	Shows the current signal strength. The greater the number of bars, the stronger the signal.
	Indicates the line is engaged.
	When this icon appears, it means that the character will be entered in low case.
	When this icon appears, it means that the character will be entered in upper case.
	When this icon appears, it means that you can only enter digits.
	Indicates battery charge level.  Fully charged status shown  Low battery  Low battery warning
	In standby mode, this icon will appear at the right of the date if you have activated sleep mode.
	This icon appears when you set an alarm to ring at a specified time.
	Indicates the microphone is temporarily muted during a conversation.
	Indicates the handsfree function is enabled.
	Indicates you have missed one or more calls, and it will disappear until you view the detail of the missed calls.
	The icon appears when lock the keypad.

- Press the navigation keys  to choose  , then press the **SELECT** key.
- Press the **▲** or **▼** key to choose **Language**, then press the **SELECT** key. The current language appears on the display.
- Press the navigation keys  to select the language you want, then press the **SELECT** key.

Changing Flash Time

During a conversation, the **R** key allows you to access the special services offered by the telephone network or transfer a call to another extension when you are connected to a PABX (Private Automatic Branch of eXchange).

If your **R** key does not work properly, you need to adjust the Flash time as follows:

- Press **MENU** key to display the main menu items.
- Press the navigation keys  to choose  , then press the **SELECT** key.
- The handset asks you to enter the current base PIN code (the default PIN is **1590**). Use the numeric keys to enter and press **SELECT** key.
- Press the **SELECT** key to access **Flash Time**, then press the **SELECT** key. The display shows the current setting.
- Press the **◀** or **▶** key to choose the desired flash time, then press the **SELECT** key. You can choose from 100ms, 120ms, 300ms or 600ms.

Note

- We recommend to contact your service provider or refer to your PABX user's manual in order to know the proper flash time to use with your telephone network.

Selecting the Windows Style

- 1 Perform steps 1 to 3 of paragraph "Adjusting the Display contrast".
- 2 Press the ▲ or ▼ key to choose **Windows Style**. The current setting appears on the display.
- 3 Press the navigation keys (⬆️⬅️⬇️⬆️) to choose among 8 pre-defined color styles, then press the **SELECT** key.

Setting a Handset name

- 1 Perform steps 1 to 3 of paragraph "Adjusting the Display contrast".
- 2 Press the ▲ or ▼ key to choose **Handset Name**, then press the **SELECT** key.
- 3 At this time, enter the name, up to 16 characters long, you want to assign to the handset and then press the **SELECT** key. You will see the ✓ icon at the right side of the **Handset Name** item.
- 4 Press the  key to return to Standby mode. You will see the result of your settings (name of the handset instead of the number of the base followed by the number of the handset.)
- 5 To deactivate this feature, press the **SELECT** key again when the LCD display shows the ✓ icon at the right side of the **Handset Name** item.

Selecting a Language

You can change the language used to display the menu messages. There are 7 different languages: English, Greek, Spanish, French, German, Dutch, and Russian.

- 1 Press **MENU** key to display the main menu items.

Package Contents

Once you have unpacked your phone, make sure that you have all the parts shown below are available. If any piece is missing or broken, please promptly call your dealer.

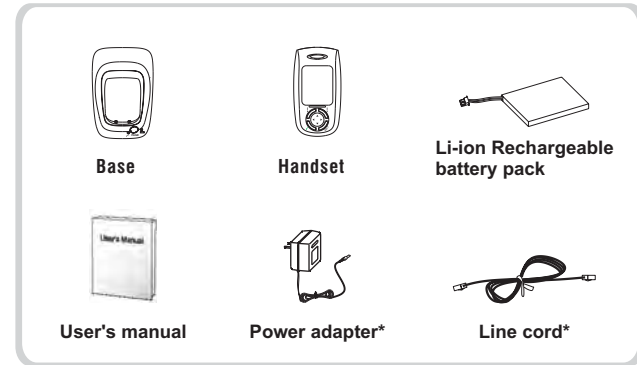

*The shape of the plugs can vary according to each country's specification.

Connection

1. Connect one end of the phone line cord to the phone line socket on the bottom of the base, and the other end to a standard phone wall outlet.

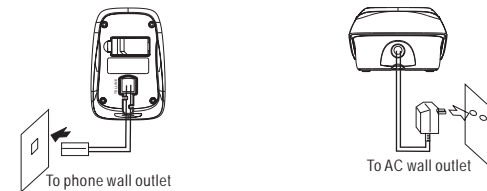

2. Connect the modular end of the power adapter to the power socket of the base, then plug the AC adapter into a standard AC wall outlet.
3. Route the cord through the routing groove as show.

Installing the Battery

The chargeable Li-ion battery comes with your phone. Install the battery before using your phone.

1. Slide the battery cover in the direction of the arrow and remove it.
2. Insert new battery as indicated, and plug the battery connector into the receptacle in the battery compartment.
3. To replace the battery cover, slide the cover up until it snaps in place.

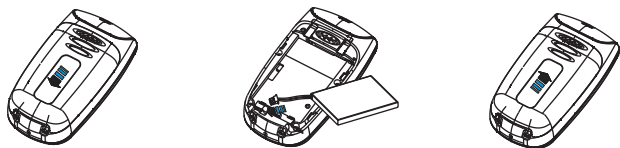

Notes

- The battery needs to be replaced if it doesn't recover its full storage capacity after recharging.
- When replacing the battery, always use a good quality Li-ion re-chargeable battery. Never use other battery types.

Charging the Handset Battery

Before initial operation, you should fully charge the handset's battery for 15 hours or more.

To charge the handset, simply place it on the base, you will hear a confirmation beep (charging beep).

Note

- When charging, the  icon on the display will scroll.

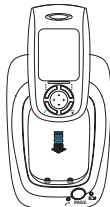



Setting Display

Using this feature, you can customize the standby display according to your taste and needs (contrast, wallpaper etc.).

Adjusting the Display Contrast

This adjustment will allow you to optimize the visibility of the display by changing its contrast according to the environment conditions.

- 1 Press **MENU** key to display the main menu items.
- 2 Press the navigation keys  repeatedly to choose , then press the **SELECT** key.
- 3 Press the **▲** or **▼** key to choose **Display setting**, then press the **SELECT** key.
- 4 Press the **SELECT** key to access **Contrast**. The current setting appears on the display.
- 5 Press the navigation keys  repeatedly to choose among the 11 available contrast levels, then press the **SELECT** key.

Selecting the Wallpaper

- 1 Perform steps 1 to 3 of previous paragraph.
- 2 Press the **▲** or **▼** key to choose **Wallpaper**, then press the **SELECT** key. The current setting appears on the display.
- 3 Press the navigation keys  to choose among 10 pre-defined wallpaper images, then press the **SELECT** key.



- 4 Press the ▲ or ▼ key to choose **Base Reset**.
- 5 The display shows "**B Reset**", press the **SELECT** key to confirm.
- 6 Press  key to exit.

Notes

- Be careful! When you reset the handset you will lose any date stored in it (e.g. name and numbers in phonebook). Don't forget to note them down before resetting the handset.
- Resetting the base does not affect the handsets registered to the base.

Setting Auto Answer

With this feature, you can answer a call by just picking up the handset from the base without pressing any key and sliding the handset open.

- 1 Press **MENU** key to display the main menu items.
- 2 Press the navigation keys  to choose  , then press the **SELECT** key.
- 3 Press the ▲ or ▼ key to choose **Auto Answer**, then press the **SELECT** key to activate the feature, and the ✓ icon will appear at the right of the **Auto Answer** item.
- 4 Press again the **SELECT** key to deactivate the function, and the ✓ icon will disappear.

Turning Handset On/Off

When you place the handset on the base, it automatically turns on.

To turn the handset on (when it's off), press the  button then you switch the display on.



To turn the handset off, keep the  button pressed until "**Goodbye!**" message appears. Then the display turns off.

Note

- Nothing will appear on the display when the battery power is very low. You should fully charge the handset before using it.

Registering a New Handset

You can register to your base additional handsets (up to 5 in total) in order to share the same line with other people. To do that you should assign a number to each new handset you will register. As you know, the supplied handset is already registered with the number 1, in fact it shows **HS(1)**. For security reasons, the registration procedure can be done only by people who are nearby your base and know the base PIN which acts as phone's authentication code.

- 1 Press and hold the  button on the base unit for about 3 seconds, then release the button.
- 2 Press **MENU** key to display the main menu items.
- 3 Press the navigation keys  repeatedly to choose  , then press the **SELECT** key.
- 4 Press the ▲ or ▼ key to choose **Register H/Set**, then press the **SELECT** key.



- 5 Press the ▲ or ▼ key to choose the base number you want. Press the **SELECT** key in order to search the base. The display shows "**Searching:**".
- 6 Press **SELECT** key to confirm, then the display asks you to enter the base PIN code (preset to **1590**) which acts as phone's authentication code (AC). Enter this code and press the **SELECT** key.
- 7 If the registration has performed successfully, the new handset will show the phone and base numbers (e.g. **HS(2) BS(1)**) and returns to Standby mode.

Note

- A handset can be registered to up to 4 different base units in order to extend the radio coverage. A base can be used with up to 5 handsets in total. Obviously the base can be accessed by one handset a time (because a base is connected to one line).

Deactivating a Handset

If necessary, you can clear the registration of a registered handset in order to stop its access to one or more base units, but you can not deactivate the handset you are using. Just follow these steps:

- 1 Press **MENU** key to display the main menu items.
- 2 Press the navigation keys  repeatedly to choose  Base Setting, then press the **SELECT** key. Enter the current base PIN (preset to **1590**) and press the **SELECT** key.
- 3 Press the ▲ or ▼ key to choose **Release Handset**, then press the **SELECT** key. Press the numeric key related to the handset number you want to clear the registration, then press the **SELECT** key. The display of the handset which you have cleared the registration shows **NOT SUB** and it cannot be used anymore with the base.



Resetting the Handset or the Base

If you reset the handset or the base, all the user selectable features restore to the factory preset initial settings: all the numbers in phonebook will be erased, as well as the incoming/outgoing call lists etc. But the Flash time can not be reset.



You can reset the handset without resetting the base or vice versa, it depends on the scope you have. It is mainly useful for these purposes:

- If you have made many wrong settings and you want to restore the handset to the factory preset initial settings.
- If the phone shows logical malfunctions (not correct symbols on the display, incorrect behavior etc.), the problem can be caused by an AC power supply noise or an electrostatic spike which can temporarily alter the memory of the internal microprocessor. In this case the reset could solve the problem.

Resetting the Handset

- 1 Press **MENU** key to display the main menu items.
- 2 Press the navigation keys  to choose  H/Set Setting, then press the **SELECT** key.
- 3 Press the ▲ or ▼ key to choose **Handset Reset**.
- 4 The handset asks you to enter the current handset PIN code (the default PIN is **1590**). Use the numeric keys to enter and press **SELECT** key, then the display shows "**Reset?**", press the **SELECT** key to confirm.
- 5 Press  key to exit.

Resetting the Base



- 1 Press **MENU** key to display the main menu items.
- 2 Press the navigation keys  to choose  Base Setting, then press the **SELECT** key.
- 3 The handset asks you to enter the current base PIN code (the default PIN is **1590**). Use the numeric keys to enter and press **SELECT** key.

Reset the Base PIN

- 1 Disconnect the adapter with the base, then the handset shows "Searching".
- 2 Hold the  key and connect the adapter again simultaneously. After the handset connects with the base and shows the handset and base number (or the handset name), the base PIN will be reset successfully.

Base Selection

Your handset can be used with up to 4 base units, provided that it has been previously registered with them. This menu option allows you to select the base you want to use:



- 1 Press **MENU** key to display the main menu items.
- 2 Press the navigation keys  to choose  **H/Set Setting**, then press the **SELECT** key.
- 3 Press the **▲** or **▼** key to choose **Select Base**, then press the **SELECT** key.
- 4 Press the **▲** or **▼** key to select the base you want, then press the **SELECT** key.
- 5 Press the  key to return to Standby mode.

Notes

- The icon  will appear at the right of the selected base.
- If the selected base has not been registered with your handset, the display will show "NOT SUB x" (x is the base number 1~4).
- At step 4 you can select "Best Base". In this case the handset will automatically find the first available unit when you lose contact while moving around.



Choosing the Dial Mode

In order to provide compatibility with other telephone systems, your phone can be set to either pulse dialling (rotary), or tone dialling (DTMF). To change the dialling mode:

- 1 Press **MENU** key to display the main menu items.
- 2 Press the navigation keys  repeatedly to choose  **Base Setting**, then press the **SELECT** key. Enter the current base PIN (preset to **1590**) and press the **SELECT** key.
- 3 Press the **▲** or **▼** key to choose **Dial Mode**, then press the **SELECT** key. The current setting appears.
- 4 Press the **◀** or **▶** key to choose **DTMF** or **PULSE**, then press the **SELECT** key to save the selection.

Setting Date & Time

In Standby mode, the unit can show the current date and time to help you keep your appointments. You need to set the date and time so that the date and time when calls are received can be displayed correctly.

- 1 Press **MENU** key to display the main menu items.
- 2 Press the navigation keys  repeatedly to choose  **Extra**, then press the **SELECT** key.
- 3 Press the **SELECT** key to choose **Clock**. The current settings are displayed: the time on the upper line in the Hours:Minutes format and the date in the Day-Month format in the lower line.

4 Enter the current date and time using the number keypad (4 digits for each as explained below in the notes).

5 Press the **SELECT** key to save the setting.

Notes

- The time setting must be entered in 24h format.
- When setting the month, you can enter 1 digit or 2 digits at a time, but it displayed in 2-digit format. (For example: To August, you can enter 8 or 08 in the month field, but the display shows 08.)
- In the state of FSK standard, the date and time will be automatically set when you receive a call to this unit.

6 Enter the new PIN code again to confirm it, then press the **SELECT** key to save the setting.

Note

- At step 4, if you enter the wrong PIN, your phone will generate a warning sound.

Changing Base PIN

1 Press **MENU** key to display the main menu items.

2 Press the navigation keys  to choose  **Base Setting**, then press the **SELECT** key.

3 The handset asks you to enter the current base PIN code (the default PIN is **1590**). Use the numeric keys to enter and press **SELECT** key.

4 Press the **▲** or **▼** key to choose **PIN Change**, then press the **SELECT** key.

5 Enter the new four-digits PIN you want to use, and press the **SELECT** key.

6 Enter the new PIN code again to confirm it, then press the **SELECT** key to save the setting.



Reset Handset and Base PIN

If you forget the handset or the base PIN code you have set, you can change the PIN codes into the default ones (1590) as follows:

Reset the Handset PIN

1 Turn off the handset.

2 Turn on the handset then hold the **0** key immediately before the handset shows "**Searching**". The display will show "**Reset PIN?**", press the right soft key to confirm. After "**Saved!**" shows on the LCD display, the PIN is reset successfully.

- 2 Press the navigation keys  to choose , then press the **SELECT** key.
- 3 Press the **▲** or **▼** key to choose **Key Tone**.
- 4 Press the **SELECT** key to activate the function, the **✓** icon will appear at the right of the **Key Tone** item.
- 5 Press again the **SELECT** key to deactivate the function, and the icon **✓** will disappear.



Note

- For a normal use, we recommend to leave the key tone enabled: they make the use of the phone easier.

Changing Handset & Base PIN

Base and handset PIN's are required to protect your phone against unauthorized use. There are set to **1590** at the factory. You can change the PIN's as follows:



Changing Handset PIN

- 1 Press **MENU** key to display the main menu items.
- 2 Press the navigation keys  to choose , then press the **SELECT** key.
- 3 Press the **▲** or **▼** key to choose **PIN Code**, then press the **SELECT** key.
- 4 Enter the current PIN code, then press the **SELECT** key.
- 5 Enter the new four-digits PIN you want to use, and press the **SELECT** key.

Making a Call

You can dial numbers up to 25 digits which are shown in the display. If the number is longer than 8 digits, the display automatically switches a smaller font in order to accommodate the whole number. You can make your calls in two ways.

Traditional mode

- 1 Slide the handset open and press the  key to engage the line. You hear a dial tone, the  icon appears in the icon area.
- 2 Dial a telephone number. The display shows the number as you have entered it. When you hear your called party, speak with a normal voice.
- 3 To end the call, press the key  or replace the handset on the base or just slide close.

High featured mode

This procedure is more convenient and reliable, because you can check the number you have entered and eventually make corrections before dialling:

- 1 Slide the handset open and enter a telephone number. Check the number on the display.
- 2 If you have made mistakes (i.e. the number you dialled is not the one you wanted to call) modify it by using the **◀** key.
- 3 When the number correctly appears, press the key  to dial it out.

Receiving a Call

When a call is received, the phone rings and the display shows "**Incoming Call**". If the incoming call can be identified (i.e. caller's information is transmitted from the network on which the call was made and the caller doesn't hide it) you will also see the caller's number in the display.

Answer the call, by pressing the  key or the **ACCPET** key or slide the handset open. Or if the handset is on the base and you have activated the "**Auto Answer**" function (See page 42 for details), simply pick it up to answer the call, you don't need to press any key and slide the handset open. During the conversation, the display shows the elapsed time.

To end the call, press the  key or replace the handset on the base or just slide closed.

Note

- The caller's identification can work only if your telephone network supports the service as well as the caller's one. However the caller can still hide his/her number.

Adjusting Voice Volume

During a conversation, press the ▲ or ▼ key to adjust the level of the earpiece volume (or the handsfree speakerphone one, if activated). You can adjust the volume in five levels which are showed by the bars of the icon . The more bars filled blue, the louder the volume. When the last bar is filled red, this means the voice volume reach the maximal level.

Muting a Call



During a conversation, you can temporarily mute the microphone so that the party on the other end of the line cannot hear you. During the period you can still hear the him/her. This mode allows you to have a conversation with someone near you and avoid that the party at the phone is hearing what you are saying.

To mute you microphone, just press the ► key during the conversation: the icon  will appear on the display.

To unmute the microphone, just press again the ► key: the icon  will disappear and you will restore the normal condition.

Selecting Ring Type & Volume

You can select your own external and internal ring sound and adjust the volume. There are 12 polyphonic ringtones, 3 ring melodies and 4 volume levels for choosing. You can also adjust the volume "0" to turn off the ringer.

- 1 Press **MENU** key to display the main menu items.
- 2 Press the navigation keys  to choose , then press the **SELECT** key.
- 3 Press the **SELECT** key to choose **Ext Calls Ringer**, or press the ▼ key to choose **Int Calls Ringer**, then press the **SELECT** key.
- 4 Press the ◀ or ▶ key to select the ring tone you like. Each time you press the ◀ or ▶ key, the handset sounds with the selected ring.
- 5 Press the **SELECT** key to save the ring tone setting and enter the ring volume setting.
- 6 Press the ◀ or ▶ key to choose the volume level you want. Each time you press the ◀ or ▶ key, the handset sounds with the selected loudness.
- 7 Press the **SELECT** key to save the setting and return to the previous menu.

Note

- Setting the volume "0" turns the ringer off. When a call comes in, only the incoming call message appears on the display.

Setting Key Tone

Every time you press a key, your handset acknowledges it with a key tone. You can disable the key tones for a silent use.



- 1 Press **MENU** key to display the main menu items.

- This function will only copy numbers stored in your SIM card. Check that all numbers you intend to copy are really stored on your SIM and not in your mobile phone's memory. Refer to your mobile phone user guide for instructions on how to do this.
- The SIM card copy is not guaranteed with all the types of SIM cards.
- If the phonebook becomes full during the transfer, the display will show **Memory Full**, and then exit.
- If the SIM card can't be read, the display shows **NO SIM**.

Country Code

If there is a long distance call number which starts with the international code followed by its(phone district) country code in the SIM card, after copying it to your phone, the international code will be automatically changed to 00 then followed by its country code and the number in the phonebook.

If you dial this number from your phonebook, the display shows 0 before the number instead of the 00 and the country code.

- 1 Press **MENU** key to display the main menu items.
- 2 Press repeatedly the  key to choose  , then press the **SELECT** key.
- 3 Press the **▲** or **▼** key to choose **Country Code**, then press the **SELECT** key.
- 4 Enter your country code (up to 4 digits), and press the **SELECT** key to save the setting.



Caller ID on Call Waiting



When you have subscribed to call waiting service from your local company, this telephone will indicate the name and number of the second caller while you are having a conversation with the first caller.

Press the **R** key to answer the second caller. When you want to transfer to the first call, press the **R** key again to continue your conversation with the first caller.

Using Speakerphone

During a call, you may turn on the speakerphone built in the handset. In this mode you can simply put your handset on a surface (e.g. a desk) and enjoy the comfort of the handsfree conversation.

To turn the speakerphone on, press the  key during a call (line engaged). The icon  appears on the display.

To turn the speakerphone off, and keep on talking in normal mode, press again the  key. The icon  will disappear.

Redialling Last Dialed Number

Your phone allows you to quickly call again the last dialed number.

Pick up the handset and press the  key to engage the line. Then press the **REDIAL** key to dial out the last dialed number.

Flash Signal

When the line is engaged, the **R** key sends the Flash signal. This key is used in conjunction with special services (e.g. call waiting, conference etc.) which can be available in your phone network. For further details please contact your network telephone company. Moreover, if you are connected to an extension of a switchboard (PABX), you can use the **R** key to locally transfer a call to another extension.

To transfer a call, or use the said special services, just press the **R** key while the line is engaged.

Using a Pause

A pause is useful when you access an interactive voice response system, such as an automated banking system. A pause provides a delay of 3 seconds.

When you are dialling a number in Standby mode and need to insert a pause, please press the **PAUSE** key one time.

Out of Range Indication

The bars at the right of the **Y** icon continuously show the signal strength received from the base. If you are too far from the base, the radio signal might become too weak and the phone might not access the telephone line. In these conditions you can't make or receive phone calls, for this reason, the **Y** icon turns to red.

Locking Keypad Handset

This function is useful to avoid unwanted function activations by accidentally pressing any keys when you are carrying your handset. If you activate the key lock, the keys are inhibited, except for the **ACCEPT** key.

If you switch the handset off and on again, the key lock is automatically disabled.

In this condition, when a call comes in, you can answer the call by pressing the **ACCEPT** key. When the call ends, the keys will be locked again.

To lock the keys, in the Standby mode just keep the ***** key pressed till the display shows the key lock icon .

To unlock the keys, keep the ***** key pressed again till the key lock icon  disappears from the display.

Paging



You can page the handset from the base unit making it ringing with a special ring. It's useful to locate a lost handset or call the user who currently has the handset.

To send the paging signal, briefly press the **Paging** key  located on the base. All the phones registered with the base ring for 15 seconds.

To stop the paging signal before 15 seconds are passed, press the **Paging** again or any keys on the handset.

Note

- If a call comes in while the handset is being paged, the handset stops the paging operation and starts ringing normally in order to allow you to answer the call.

- 3 Remove the SIM card from your cellular phone by following the instructions stated in its user's manual.
- 4 Carefully slide the SIM card inside the base slot keeping the smoothed corner on bottom left and the golden contacts toward the slot ones. Make sure that the SIM card slides under the guides on either side of the reader.
- 5 Press the **MENU** key in standby mode, then press repeatedly the  keys to choose  and press the **SELECT** key to access the phonebook.
- 6 Press the **▲** or **▼** key to choose **Read SIM**, and press the **SELECT** key.
- 7 If the SIM card is protected with a PIN, the display will ask you to enter it with the message **SIM PIN:**. Enter the PIN, then press the **SELECT** key. If you enter an incorrect PIN, the display will show **PIN ERROR**.
- 8 The display will show "**Checking SIM...**" and then show the copy progress in percentage, but the progress will pause on the last entry, and then the display will show "**Verifying**". When finished, you can see **FINISHED** in the display and hear a confirmation beep.
- 9 Remove the SIM card and replace it into your phone.
- 10 Replace the SIM card slot cover by fitting its two small tabs into the two slots of the base slot and gently push the cover toward the base till it snaps into its original place.

Notes

- Even if the SIM card is placed in the base, the phonebook contents are transferred in the handset's memory (not in the base), so the base acts only as a wireless SIM card reader.
- The numbers contained in the SIM phonebook are copied into the handset one and added to the entries already stored in it which are not overwritten. The maximum number of entries is 250. If your handset phonebook already contains 200 entries, only the first 50 entries on the SIM card will be copied.

Using Phonebook Entries Options

You can edit, delete or dial it in the Phonebook as follows:

- 1 Find the desired number in the phonebook.
- 2 Press the **SELECT** key to view the details of the selected entry.
- 3 Press the **SELECT** key to display the option menus.
- 4 Press the **▲** or **▼** key to choose the desired option:
 - **Edit** - allows you to edit the number in the phonebook.
 - **Delete** - deletes the selected phonebook entry.
 - **Delete All** - deletes all the phonebook entries.

SIM Card Reading

With this feature you can copy the contents of your mobile phone's SIM card phonebook into the phonebook of your DECT cordless phone.

- 1 Disconnect the telephone line (for security reasons as below stated).
- 2 Open the SIM card slot cover in the bottom of the base by moving downward the SIM card latch, then remove the cover and keep it.

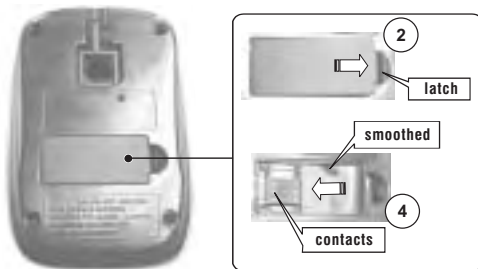



Temporary Tone Dial Switchover

If you are using the pulse dialling because your telephone line doesn't support tone dialling, you might not be able to access certain external services (e.g. automatic call centres, voice mailboxes, interactive telephone systems etc.), because they need the tone dialling. You can avoid this limitation and access them anyway doing this:

- 1 Slide the handset open and press the  key to engage the line.
- 2 Press and hold the * key until "-" is displayed: your phone is temporarily to the tone dial mode.
- 3 Enter the number of the service you need to access as you do normally.
- 4 When you hang up, the phone automatically returns to the pulse mode.

Intercom

If you connected more than one handset to a base (you can connect up to 5 handsets to the same base), you can have a conversation between two people using two different handsets.

- 1 Pick up the handset and press the **◀** key, the display shows "INT->".
- 2 Press the number of the handset you want to contact (from 1 to 5). Then the called handset starts to ring.
- 3 If the called party can answer your call, he/she can press the  key and start talking. You can see the number of the handset of your called party and the  icon in your LCD display.
- 4 At the end of the conversation press the  key to return to Standby mode.

Call Transfer between Handsets

If you have more handsets registered to the same base, you can transfer an outside call between the registered handsets.

- 1 When you are connected to an external call, press the ◀ key and the number of the handset you want to contact (from 1 to 5).
- 2 If the called party can answer your call, he/she can press the ☑ key and start talking.
- 3 If you want to transfer the incoming call before the called party answer, just press the ◀ key of your handset. The call will be transferred.

Setting Up a Three-way Conference Call



When you have both an external call and an intercom call in progress, you can set up a three-way conference call, like this

Press and hold # key of the your handset for more than 2 seconds to set up a three-way conference call.

Review/Dialling a Number in Phonebook

You can search the entries stored in the phonebook by entering the first initial characters of their names (alphabetic search). You can also scroll through the whole list of the phonebook entries in Standby mode without accessing the **Phonebook** menu.

Way 1: Alphabetic search

- 1 Press **MENU** key to display the main menu items.
- 2 Press repeatedly the  key to choose  , then press the **SELECT** key.
- 3 Press the **SELECT** key to access **Review**.
- 4 Enter the first few letters of the name by using the alphanumeric keys, and press the **SELECT** key. You can view the details of the selected entry.
- 5 Press the ☑ key to dial it.

Way 2: Searching by scrolling the phonebook list

- 1 Press the ▼ key in Standby mode. The display shows the whole list of all of the Phonebook entries in alphabetical order.
- 2 Repeatedly press the ▲ or ▼ key to scroll to the desired entry.
- 3 Press the **SELECT** key to view the details of the selected entry.
- 4 Press the ☑ key to dial it.

Way 2: in Standby mode

- 1 Enter a phone number in Standby mode, then press the **SAVE** soft key.
- 2 Complete storing the entry by starting from step 4 described in the last paragraph of **Way 1**.

Notes

- When you are entering the number in step 1, you can also insert one or more dialling pauses in order to store them in the phonebook as well.

Character Map

To enter a specific alphanumeric character, press one or more times the relevant key for the required character according to the following table: once for the first character, twice for the second and so on.

Key	Characters in the displayed order
0	(spc) 0 € £ \$ ¥ i ÷ ÷
1	1 . , ; ? ! - * # @ & / : () "
2	A B C a b c 2 ä à Å Ç
3	D E F d e f 3 É è é
4	G H I g h i 4 ì
5	J K L j k l 5
6	M N O m n o 6 Ñ Ö ñ ö ò
7	P Q R S p q r s 7 ß
8	T U V t u v 8 Ü ü ù
9	W X Y Z w x y z 9 Æ Ø Å æ ø å

Notes

- To delete letters, use the **CLEAR** key.
- If you want to shift the case while entering letter, press the **#** key.
- When entering the same letter twice or a different letter on the same key, wait for a few seconds for the cursor to move automatically, and then select the next letter.

Incoming Calls

When you receive a call, if the caller's information is transmitted from the network on which the call was made (and the caller doesn't hide it), the caller's phone number is displayed. Moreover, when there is a received call which you missed, the pop up message "**Missed Call**" followed by the number of missed calls (01, 02, etc.) and the icon  will appear on the LCD until you view the details of the missed call.

The last 30 received (or missed) calls are stored in the **Incoming Calls** list, and you can call the said numbers back, delete or store them in the phonebook. To view the number you can go to the **Incoming Calls** list.

Review/Dialling a Number in Incoming Calls List

- 1 In Standby mode, press the **LIST** key.
- 2 Press the **SELECT** key to access **Incoming Calls**. The list of incoming calls is displayed on the screen.
- 3 Scroll through the incoming calls list using the **▲** or **▼** key until you find the desired number, and press the **SELECT** key. You will see the date/time in which you received the call.
- 4 To place a call to the number, press the  key.

Notes

- At step 2, if the list is empty, the display will show "**No Call**".
- At step 3, each item of the incoming list is marked with the **↑** icon if the call was really a received call or with the **↓** icon if the call was missed (not answered or dropped before you could do that). If a missed call has viewed the detail, then the icon **↓** will disappear. If a caller's number repeat, the **+** icon appears in the middle of the icons area.
- When the LCD display shows the message "**Missed Call xx**", you can press the **OK** key to access the Incoming Calls list to view the details or press the **CANCEL** key to return to the Standby mode.
- "**Private**" shows on the display and it will be stored in the incoming call list, if the caller has exercised the option to prevent his name and number from being sent.
- "**Out of area**" will show and be stored in the incoming call list when someone calls from an area where the telephone company is not offering the caller identification services or an area that is not yet providing name and number delivery to your area via the long distance net work.
- "**Error**" will show if the phone can not recognize the information within the caller display messages properly.
- Date and time of the calls can be seen only if you have previously set the date and time.
- If a incoming call number is longer than 16 digits, the **>>** icon shows at the right side of the time.



Using Incoming Calls Options

You can save, delete or dial a number in the incoming calls list as follows:

- 1 Find the desired number in the incoming calls list.
- 2 Press the **SELECT** key to display the information of the call.
- 3 Press the **SELECT** key to display the option menus.
- 4 Press the **▲** or **▼** key to choose the desired option:
 - **Add to Phonebook** - allows you to save the number in the phonebook. If the number is longer than 16 digits, the display shows "**Copy 16 digits?**", press the **SELECT** key to copy 16 digits of the number to the phonebook.
 - **Delete** - deletes the selected incoming call number.
 - **Delete All** - allows you to delete the whole incoming calls list (a message asks if you really want to delete all the entries). Press the **SELECT** key to confirm or **CANCEL** to exit without deleting the entries.

Outgoing Calls

The last 20 outgoing calls are stored in the **Outgoing Calls** list. You can review, redial and save the last 20 dialled numbers.

- 1 In Standby mode, press the **LIST** key.
- 2 Press the **▲** or **▼** key to choose **Outgoing Calls**, then press the **SELECT** key. The last dialled number is displayed on the screen.
- 3 Press the **▲** or **▼** key to find the desired number. Press the **SAVE** key to add it to phonebook.
Or press the  key to redial it. If you want to insert a pause, you only need to move the cursor to the desired location and then press the **Pause** key.
Or press and hold the  key to delete it.
- 4 Press **◀** key to delete the number digits one at a time then exit or wait for the unit to time out and return to Standby mode.

Note

- At step 2, if the list is empty, the display will show "**No Call**".



Phonebook

The phonebook built in your cordless phone allows you to store frequently used numbers so that you can easily make a call without having to remember or enter the phone number. Moreover, it reduces the risks of wrong dialling. You can store up to 250 entries in your internal phonebook.



You can store the phonebook entries in the below stated modes: by using the phonebook menu or in Standby mode.

Storing Phonebook Entries

Way 1: by using the phonebook menu

- 1 Press **MENU** key to display the main menu items.
- 2 Press repeatedly the  key to choose  , then press the **SELECT** key.
- 3 Press the **▲** or **▼** key to choose **Add entry**, then press the **SELECT** key.
- 4 Enter a name that you want to use. For details of entering a name please see the "**Character Map**".
- 5 Press the **▼** key in order to move the cursor to the number field, then enter the appropriate phone number.
- 6 Press the **▼** key in order to highlight the ring type number at the right of  icon, then press the **◀** or **▶** key to select the ring you like to associate to the number. Every time you select a ring, the phone sounds with it.
- 7 Press the **SELECT** key to save the setting.

Notes

- At step 4, to shift the case, press the **#** key while entering text.
- At step 5, the  or  icon is changed to the  icon. It indicates that you can only enter digits.
- If you make a mistake while entering a number or name, press the **CLEAR** key to clear the last character. You can also use the **◀** or **▶** key to move on others wrong characters, then press the **CLEAR** key to clear them.