



MOTOROLA

**User's Guide
For LS1000**

**10.4" Digital Photo Frame
with Slideshow**



Warning

Use only the power adapter supplied with your product.

Welcome...

to your new Motorola Digital Photo Frame!

Please retain your original dated sales receipt for your records. For warranty service of your Motorola product, you will need to provide a copy of your dated sales receipt to confirm warranty status. Registration is not required for warranty coverage.

For product-related questions, please call:

1-888-331-3383 in US and Canada

0845 218 0890 in UK

(65) 68412668 in Singapore

On the Web: www.motorola.com

This User's Guide provides you with all the information you need to get the most from your digital photo frame.

Before you start using, you will need to set up your digital photo frame. Follow the simple instructions in "Getting started", on the next few pages.

IMPORTANT

- Only use the supplied power adapter.

Got everything?

- 1 x Digital Photo Frame
- 1 x Stand
- 1 x Power adapter
- 1 x Remote control
- 1 x Quick Start Guide
- 1 x User's Guide

Key features

- 3 view modes: Clock/Calendar mode, slideshow mode and thumbnail mode
- 5 slideshow transition effects
- Date and Time settings
- Programmable On/Off Time
- Supports flash drive, SD, SDHC and MMC memory cards.

Frame Overview

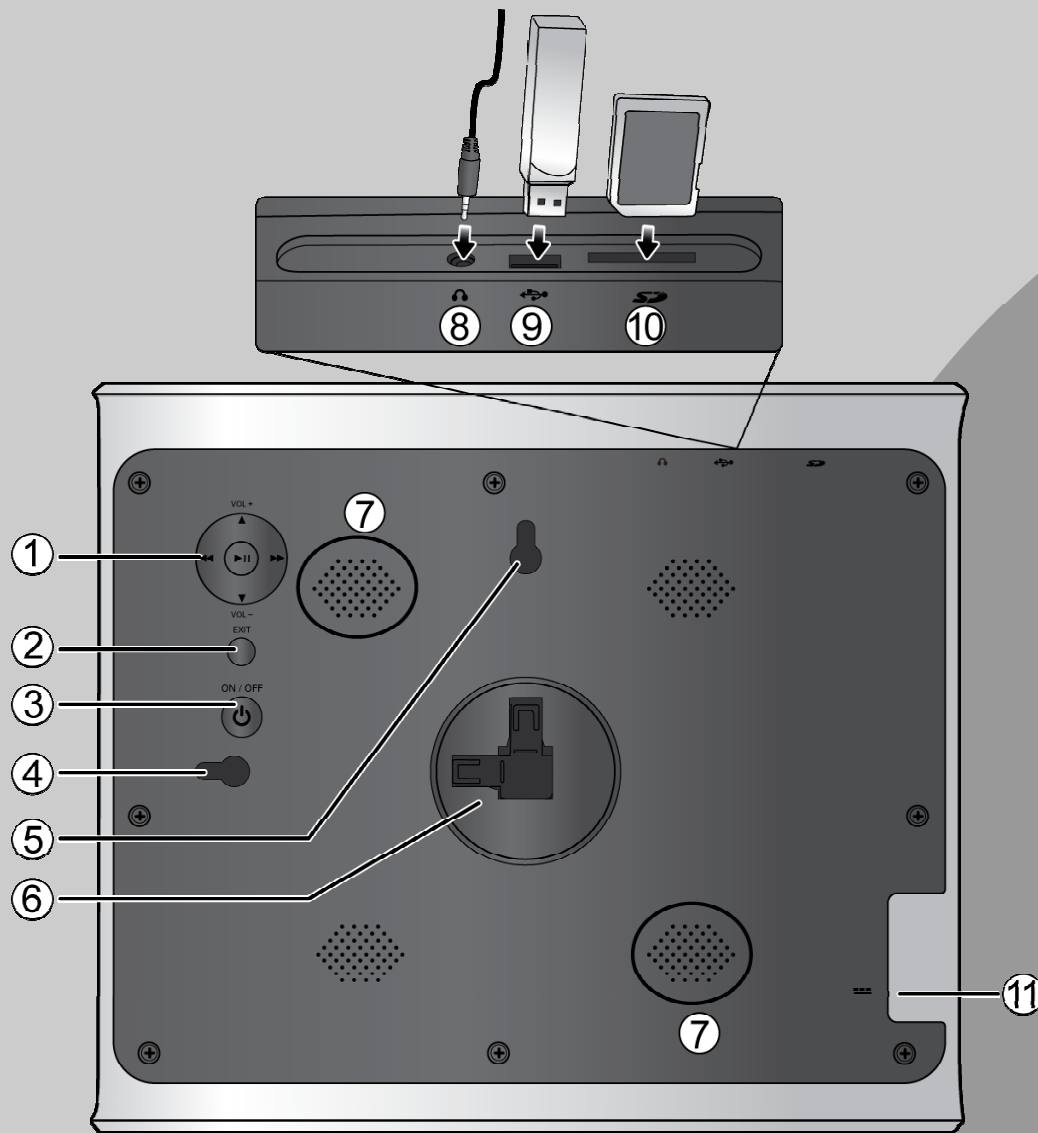

1. Navigation and  buttons
2. EXIT button
3. ON/OFF button
4. Hanging slot (Portrait position)
5. Hanging slot (Landscape position)
6. Stand locking slot
7. Loudspeakers
8. Earphone jack
for connecting to an earphone/headset or external speaker to play the audio.
9. USB port
for inserting a USB flash drive that contains the photos or music you want to play.
10. Memory card slot
for inserting an SD, SDHC, MMC memory card that contains the photos or music you want to play.
11. Power jack



Table of Contents

- 1. **Getting started**5
 - 1.1 Installing the stand6
 - 1.1.1 Landscape position6
 - 1.1.2 Portrait position7
 - 1.2 Connecting to power8
 - 1.3 Inserting a memory card or a USB flash drive8
 - 1.4 Replacing the remote control battery9
- 2. **Using the photo frame**.....10
 - 2.1 Using the control buttons10
 - 2.2 Using the remote control13
- 3. **Using the menus**.....15
 - 3.1 Using the Main Menu15
 - 3.2 Using the Photo menu.....16
 - 3.2.1 Copying one or all photos17
 - 3.2.2 Deleting one or all photos18
 - 3.2.3 Auto rotation18
 - 3.3 Using the Music menu.....19
 - 3.3.1 Copying one or all music files20
 - 3.3.2 Deleting one or all music files21
 - 3.4 Using the Calendar menu21
 - 3.5 Using the Settings menu22
 - 3.5.1 Setting an alarm25
 - 3.5.2 Enabling auto on/off26
- 4. **General information**27
- 5. **Technical specifications**33
- 6. **Wall mounting instructions**.....35

1. Getting started

WARNING

- *Do not place your digital photo frame in the bathroom or other humid areas.*
- *Do not place your digital photo frame near sources of heat and extreme temperatures, such as fluorescent lighting, microwave ovens, heating appliances and direct sunlight.*
- *Do not disassemble your digital photo frame; there are no user-serviceable parts inside.*
- *If the LCD screen breaks, do not touch the glass or liquid. Contact Motorola customer support for assistance.*
- *Use only the power adapter supplied with your digital photo frame.*

Compatible photo format

Your digital photo frame can only display photos that are in JPEG format. Other photo formats may not be detected or displayed correctly.

Care and maintenance

Wipe the frame and the LCD screen gently with a soft, clean, dry cloth.

To remove fingerprints on the LCD screen, wipe gently with a soft, lint-free cloth. Do not use cleaning solutions unless they are designed specifically for LCD screens.

IMPORTANT

Always switch off and disconnect the power adapter before cleaning the digital photo frame.



1.1 Installing the stand

1.1.1 Landscape position

To place the photo frame in landscape position, follow the steps below to install the stand.

1. Hold the photo frame in landscape position.
2. Attach the stand to the stand locking slot on the back of the photo frame.

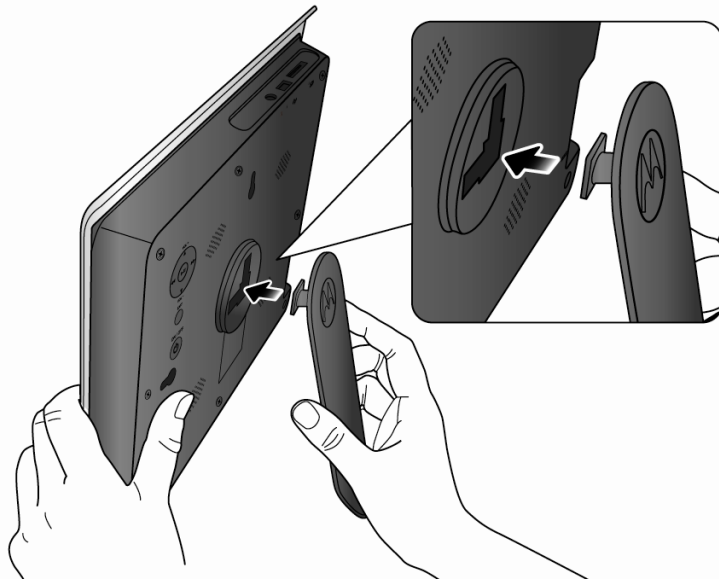

3. Insert the stand into the stand locking slot as illustrated, until the stand is secured to the photo frame.

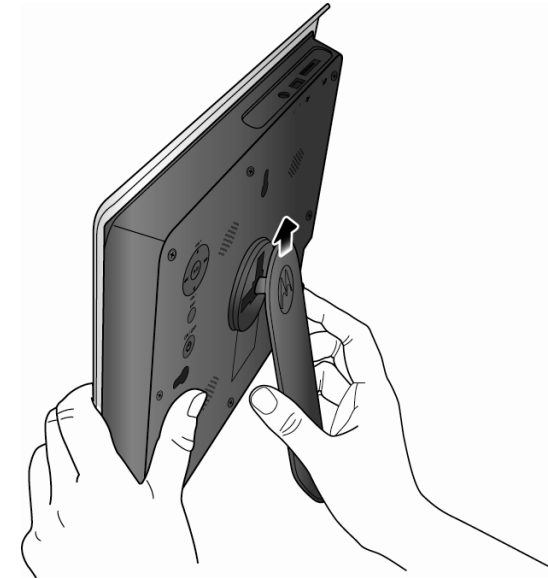

WARNING

- Do not rotate the stand during the installation. Otherwise, the photo frame will be damaged.
- Once the installation is complete, place the photo frame on a stable surface to avoid any possible movement.

1.1.2 Portrait position

To place the photo frame in portrait position, follow the steps below to install the stand.

1. Hold the photo frame in portrait position.
2. Attach the stand to the stand locking slot on the back of the photo frame.

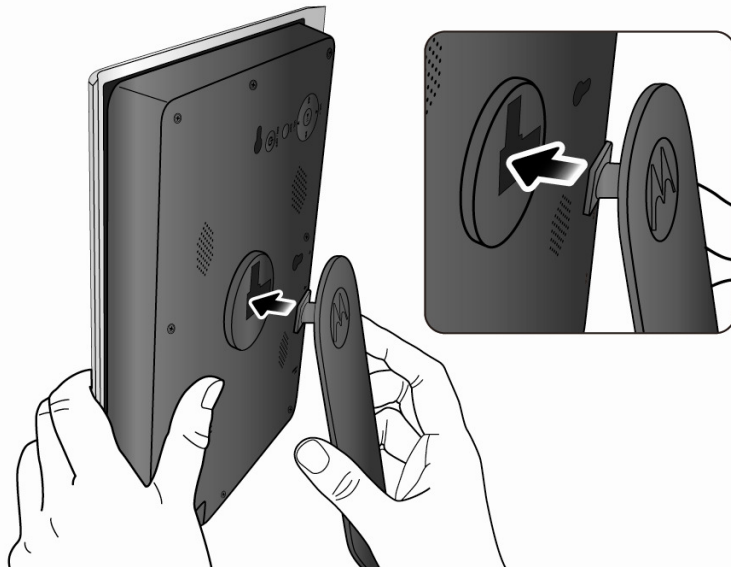

3. Insert the stand into the stand locking slot as illustrated, until the stand is secured to the photo frame.



WARNING

- Do not rotate the stand during the installation. Otherwise, the photo frame will be damaged.
- Once the installation is complete, place the photo frame on a stable surface to avoid any possible movement.



1.2 Connecting to power

Follow the steps below to connect the photo frame to a power outlet to turn on the power.

1. Plug one end of the AC power adapter to the power jack on the back of the photo frame.
2. Plug the other end into a power outlet. The power of the photo frame will be turned on.

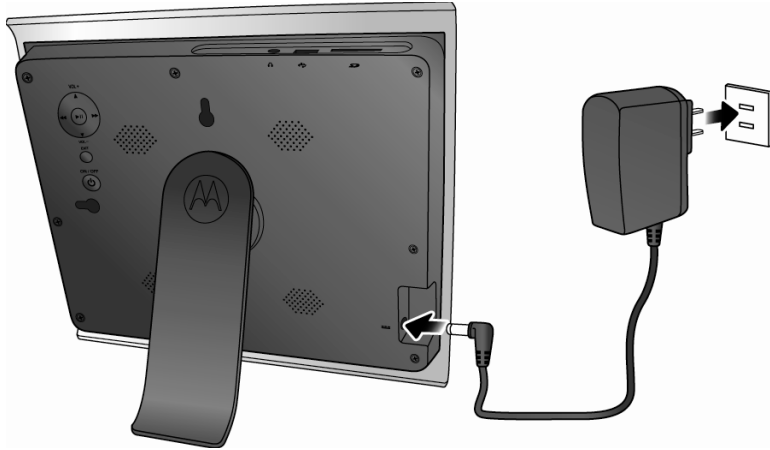

3. Place the photo frame in landscape or portrait position on a stable surface.

NOTE

Available plug types may vary depending on where you purchased this photo frame.

1.3 Inserting a memory card or a USB flash drive

The photo frame is preloaded with some photos in the internal memory. On the top of the photo frame, you can also insert a memory card or a USB flash drive containing the content you want to show on this unit.

NOTE

- After you insert a photo-loaded memory card or USB flash drive and connect the photo frame to power, the photo frame will automatically start to display photos in slideshow mode.
- The memory card slot and USB port both support hot-swap function.
- The memory card slot accepts these types of memory cards: SD, SDHC, MMC.
- You can play audio and image files on the photo frame. The supported audio file format is MP3 (*.mp3). The supported image file format is JPEG (*.jpg).
- Video files are not supported on this photo frame.

1.4 Replacing the remote control battery

The supplied remote control comes installed with a CR2025 lithium battery. When you need to replace the battery, follow the steps below.

1. Slide the locking tab to the right.

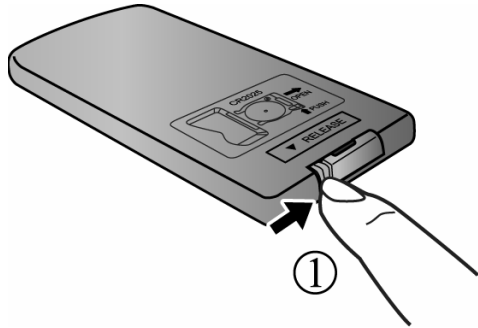

2. Pull out the battery holder.

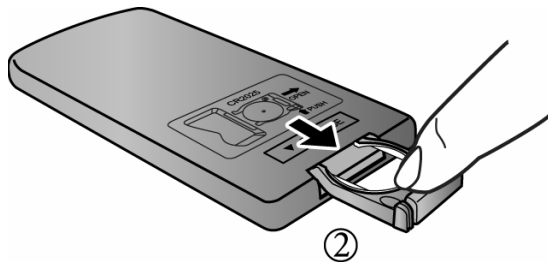

3. Insert the new battery into the battery holder. The battery must be placed with the positive pole facing upwards in the illustrated position.

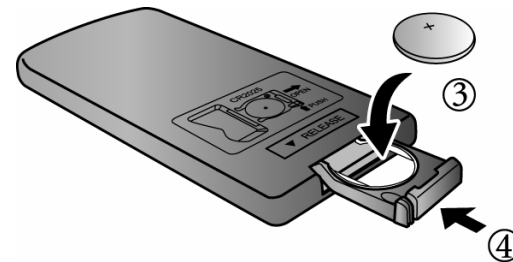

4. Slide the battery holder into the remote control.

WARNING

- *Protect the battery from overheating or excessive moisture.*
- *Failure to replace the battery in the correct manner may result in damage to the battery.*
- *Use only the approved specified batteries.*
- *Properly recycle or dispose of used batteries according to local guidelines and regulations.*
- *Do not throw batteries into fire. This may result in an explosion.*
- *If the battery is completely drained or the remote control is not in use for a long time, remove the battery to prevent leakage.*

2. Using the photo frame

To operate the photo frame, you can:



- Use the control buttons on the back of the photo frame

Or

- Use the supplied remote control

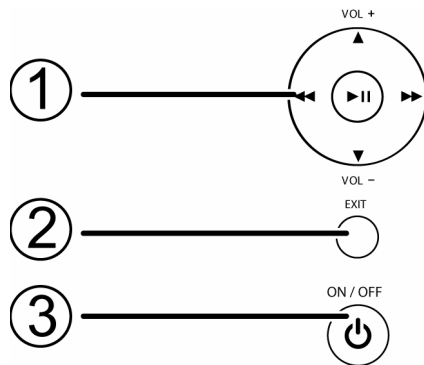
2.1 Using the control buttons

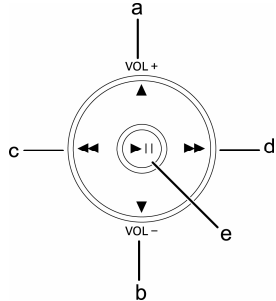

No.	Description
1	<p>Navigation and  buttons</p>  <p>a. UP/VOL +: moves up/increases the volume. b. DOWN/VOL -: moves down/decreases the volume. c. RIGHT: moves right. d. LEFT: moves left. e. : Enters/confirms the selection, or starts/pauses the playback.</p>
2	<p>EXIT button</p> <ul style="list-style-type: none"> • Returns to the Main Menu. • Goes back to the previous page. • Stops the playback.
3	<p>ON/OFF button</p> <ul style="list-style-type: none"> • Turns on the screen backlight. • Turns off the screen backlight to enter Standby mode.

When using the Main Menu	
Button	Function
UP/VOL +	Selects Internal Memory, USB or Memory Card .
DOWN/VOL –	Selects Internal Memory, USB or Memory Card .
LEFT	Selects Photo, Music, Calendar or Settings menu.
RIGHT	Selects Photo, Music, Calendar or Settings menu.
	Enters sub-pages of Photo, Music, Calendar or Settings menu.

When browsing photos in thumbnail view	
Button	Function
UP/VOL +	Moves up.
DOWN/VOL –	Moves down.
LEFT	Moves left.
RIGHT	Moves right.
	Displays the currently selected photo in Single Photo view.
EXIT	Goes back to the previous page.

When playing a slideshow	
Button	Function
	Starts/pauses the playback.
EXIT	Goes back to the previous page.

When using the Music menu	
Before playing music / When music is paused	
Button	Function
UP/VOL +	Selects the previous track.
DOWN/VOL –	Selects the next track.
LEFT	Selects the previous track.
RIGHT	Selects the next track.
When playing music	
Button	Function
UP/VOL +	Increases the volume.
DOWN/VOL –	Decreases the volume.
LEFT	Selects the previous track.
RIGHT	Selects the next track.



When using the Calendar menu	
Button	Function
LEFT	Selects Photo , Music , Calendar or Settings menu.
RIGHT	Selects Photo , Music , Calendar or Settings menu.
	Enters Calendar full screen mode when the Calendar menu is selected.
EXIT	Goes back to the previous page.

When using the Settings menu	
Button	Function
UP/VOL+	Moves up to the previous sub-menu in Settings .
DOWN/VOL-	Moves down to the next sub-menu in Settings .
LEFT	Selects Photo , Music , Calendar or Settings menu.
RIGHT	Selects Photo , Music , Calendar or Settings menu.
	<ul style="list-style-type: none">• Enters sub-menus in Settings.• Enters/confirms the selection.
EXIT	<ul style="list-style-type: none">• Quits sub-menus in Settings.• Goes back to the previous page.

2.2 Using the remote control

The following table describes the buttons and their functions that are available on the supplied remote control.

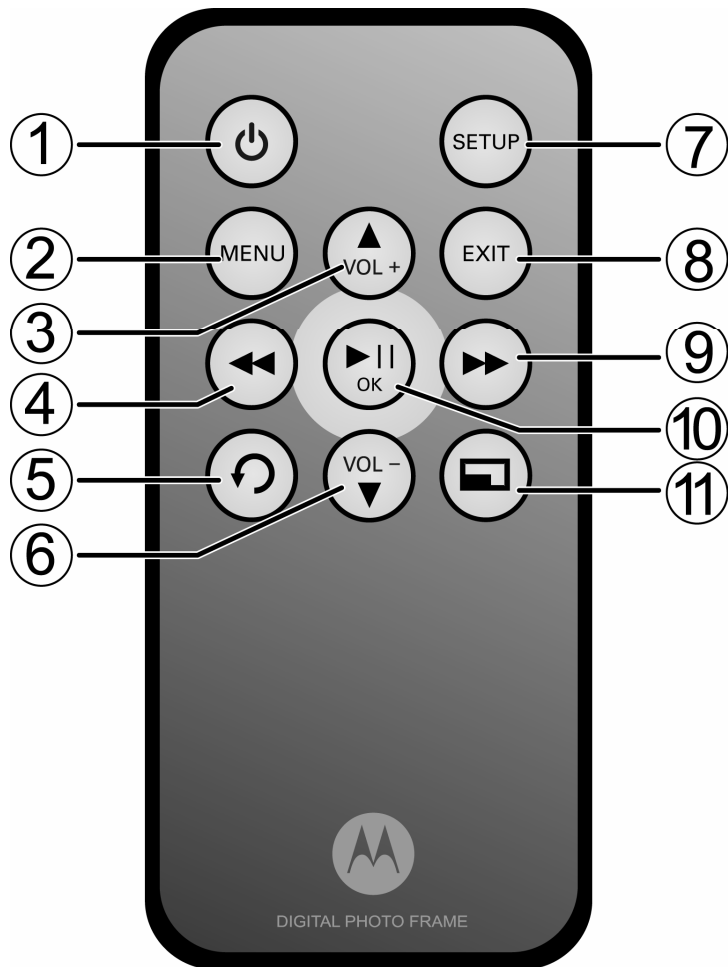

No.	Description
1	ON/OFF <ul style="list-style-type: none"> Turns on the screen backlight. Turns off the screen backlight to enter Standby mode.
2	MENU You can press this button to activate or deactivate Copy One, Copy All, Delete One or Delete All options in Photo Viewer and Music Player .
3	UP/VOL + Moves up or increases the volume.
4	LEFT/PREVIOUS Moves left or selects the previous item.
5	ROTATE You can press this button repeatedly to rotate the selected photo counterclockwise each time by 90 degrees.
6	DOWN/VOL - Moves down or decreases the volume.
7	SETUP You can press this button to access the Settings menu.

(Continued on next page)



No.	Description
8	EXIT Goes back to the previous page.
9	RIGHT/NEXT Moves right or selects the next item.
10	 (OK/PLAY/PAUSE) Enters and confirms the selection, or starts/pauses the playback.
11	ZOOM Zooms in the photo by a factor of 2x, 4x, 8x and 16x.



3. Using the menus

3.1 Using the Main Menu

After turning on the power of the photo frame, photos will play in slideshow mode automatically.

- If a memory card has been inserted, photos in the card will play in slideshow mode automatically.
- If no memory card is inserted, photos in the built-in memory will play in slideshow mode automatically.

To exit slideshow mode and return to the **Main Menu**, press the **EXIT** button on the back of the photo frame.



NOTE

To check the available space in Internal Memory, USB or Memory Card, select **Internal Memory**, **USB** or **Memory Card** and check the amount of free space shown on the bottom right corner.

In the **Main Menu**, you can:

- Press the **LEFT** or **RIGHT** button to select the **Photo**, **Music**, **Calendar** or **Settings** menu.
- Press the **UP/VOL+** or **DOWN/VOL-** button to select a device, including **Internal Memory**, **USB** or **Memory Card**.





3.2 Using the Photo menu

NOTE

The photo frame only supports JPEG (*.jpg) image file format.

1. In the **Main Menu**, press the **LEFT** or **RIGHT** button to select the **Photo** menu.
2. Press the **UP/VOL+** or **DOWN/VOL-** button to select a device.
3. Press the  button to enter **Photo Viewer**, which displays your photos in thumbnail view. In **Photo Viewer**, both photos and folders may display, depending on the content stored in your device.





- To browse or select a photo, use the **UP/VOL+**, **DOWN/VOL-**, **LEFT** and **RIGHT** buttons.
- To play photos in full screen single photo mode, press the  button. Press the  button again to start running slideshow.
- To make photos play with background music in slideshow mode, go to the **Settings** menu to set **Music slideshow** to **On**. (This function is only available when you have music files in the internal memory or inserted memory card/USB flash drive.)
- To switch to the previous or next photo in slideshow mode, press the **LEFT** or **RIGHT** button.
- To control the slideshow music volume, press the **UP/VOL+** or **DOWN/VOL-** button.
- To rotate a photo, press the **ROTATE** button on your remote control.
- To zoom in a photo, press the **ZOOM** button on your remote control.

3.2.1 Copying one or all photos

NOTE

- To copy photos from your memory card or USB to the internal memory, please insert your memory card or USB flash drive first.
 - Use the supplied remote control for this operation.
1. In **Photo Viewer**, press the **MENU** button on the remote control. **Copy One**, **Copy All**, **Delete One** and **Delete All** options will appear on the screen.



2. Press the **LEFT** or **RIGHT** button to select **Copy One** or **Copy All**, and then press the  button.
3. Press the **LEFT** or **RIGHT** button to select **Yes**, and then press the  button.
4. Press the **LEFT** or **RIGHT** button to select the destination (**USB**, **Memory Card** or **Internal Memory**), and then press the  button to confirm.



Once the copy process starts, do not remove your USB or memory card from the photo frame before the “Complete” message appears.



3.2.2 Deleting one or all photos

NOTE

Use the supplied remote control for this operation.

1. In **Photo Viewer**, press the **MENU** button on the remote control. **Copy One**, **Copy All**, **Delete One** and **Delete All** options will appear on the screen.
2. Press the **LEFT** or **RIGHT** button to select **Delete One** or **Delete All**, and then press the  button.
3. Press the **LEFT** or **RIGHT** button to select **Yes**, and then press the  button to confirm.

3.2.3 Auto rotation

The photo frame has a built-in tilt sensor that allows the photo frame to determine its own orientation relative to gravity and thereby automatically switch from displaying photos in portrait view to displaying photos in landscape view.



3.3 Using the Music menu

NOTE

The photo frame only supports MP3 (*.mp3) audio file format.

1. In the **Main Menu**, press the **LEFT** or **RIGHT** button to select the **Music** menu.
2. Press the **UP/VOL+** or **DOWN/VOL-** button to select a device.
3. Press the  button to enter **Music Player**.

- To select the previous track, press the **UP/VOL+** or **LEFT** button.
- To select the next track, press the **DOWN/VOL-** or **RIGHT** button.
- To play the selected track, press the  button.
- During music playing, volume bar shows on top right corner. To increase or decrease the volume, press the **UP/VOL+** or **DOWN/VOL-** button.

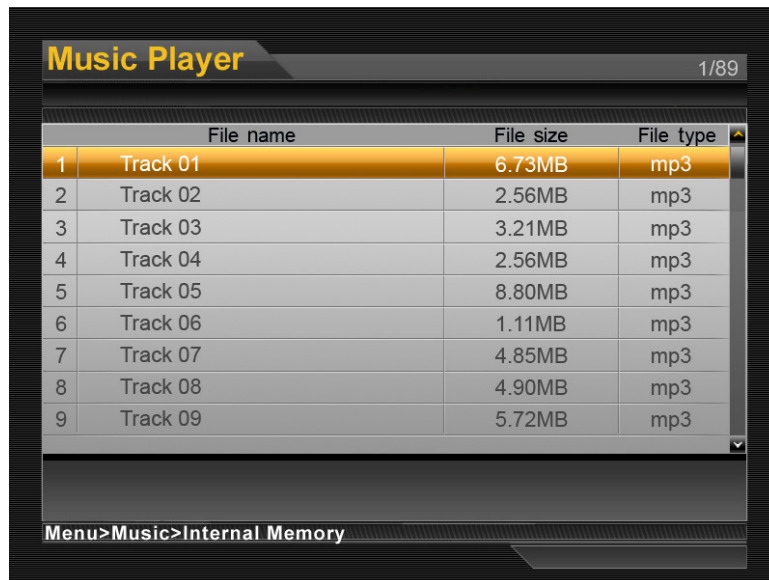





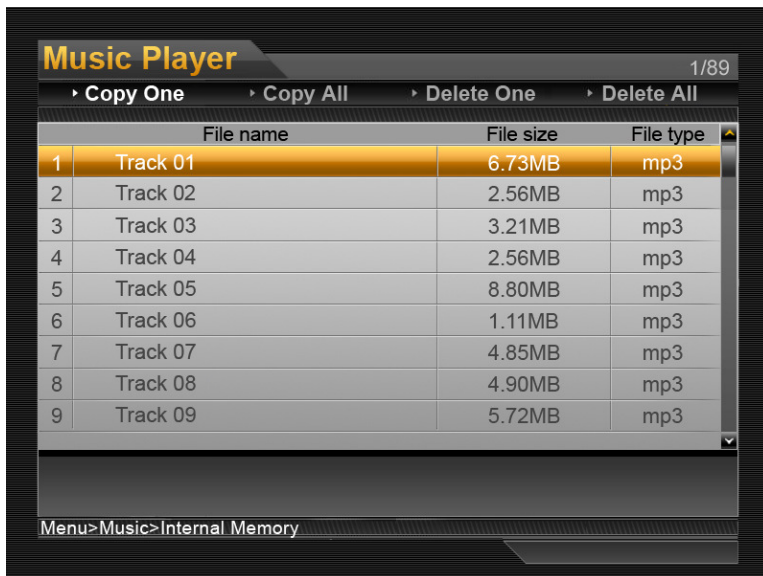

3.3.1 Copying one or all music files

NOTE

- To copy music files from your memory card or USB to the internal memory, please insert your memory card or USB flash drive first.
 - Use the supplied remote control for this operation.
1. In **Music Player**, press the **MENU** button on the remote control. **Copy One**, **Copy All**, **Delete One** and **Delete All** options will appear on the screen.



2. Press the **LEFT** or **RIGHT** button to select **Copy One** or **Copy All**, and then press the  button.
3. Press the **LEFT** or **RIGHT** button to select **Yes**, and then press the  button.
4. Press the **LEFT** or **RIGHT** button to select the destination (**USB**, **Memory Card** or **Internal Memory**), and then press the  button to confirm.



Once the copy process starts, do not remove your USB or memory card from the photo frame before the “Complete” message appears.



3.3.2 Deleting one or all music files



NOTE

Use the supplied remote control for this operation.

1. In **Music Player**, press the **MENU** button on the remote control. **Copy One**, **Copy All**, **Delete One** and **Delete All** options will appear on the screen.
2. Press the **LEFT** or **RIGHT** button to select **Delete One** or **Delete All**, and then press the  button.
3. Press the **LEFT** or **RIGHT** button to select **Yes**, and then press the  button to confirm.

3.4 Using the Calendar menu

1. In the **Main Menu**, press the **LEFT** or **RIGHT** button to select the **Calendar** menu.

2. Press the  button to enter the **Calendar** preview screen, and then press the  button again to enter full screen mode in the **Calendar** menu. The slideshow automatically starts.

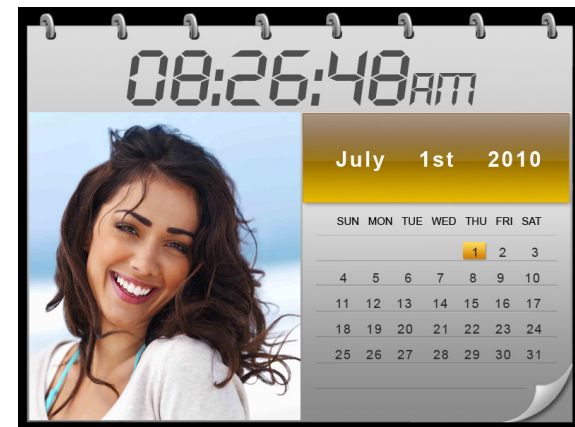



3. In full screen calendar mode, you can press the  button to display one specific still photo or enter slideshow mode. To switch to next or previous photo, press the **RIGHT** or **LEFT** button.

NOTE

If you have set the alarm, an alarm icon will show on the Calendar screen. For details about alarm settings, refer to "3.5.1 Setting an alarm".



3.5 Using the Settings menu

1. In the **Main Menu**, press the **LEFT** or **RIGHT** button to select the **Settings** menu.
2. Press the  button to enter the **Settings** menu.
 - To move among sub-menus under **Settings**, press the **UP/VOL+** or **DOWN/VOL-** button.
 - To apply the settings you have selected, press the  button.
 - To go back to the previous page, press the **EXIT** button.

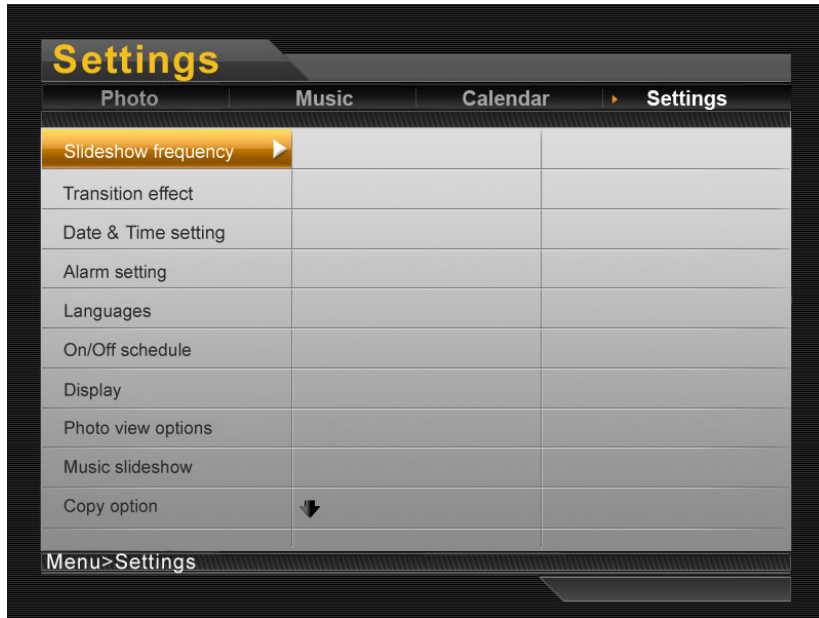

You can control all function settings of the photo frame from the **Settings** menu. Refer to the table below for more information.

Sub-menu	Option	Description/Function
Slideshow frequency	5 seconds	Selects the speed of slideshow.
	10 seconds	
	30 seconds	
	1 minute	
	1 hour	
	1 day	
Transition effect	No effect	Selects the transition effect to be applied in slideshow.
	Random	
	Fade out	
	Fade in	
	Left to Right	
	Horizontal open	
	Horizontal close	

(Continued on next page)



Sub-menu	Option	Description/Function
Date & Time setting	Year	Allows you to set up the date and time.
	Month	
	Day	
	Hour	
	Minute	
	Time Format	
Alarm setting	Alarm on/off	Activates/deactivates the alarm clock function.
	Alarm hour	Sets the alarm hour.
	Alarm minute	Sets the alarm minute.
	Volume	Sets the alarm volume level.
	Tone	Selects the type of alarm tones: Beep or MP3
	Day	Allows you to set the alarm recurring everyday or on weekdays.

Languages	English	Selects an OSD (On-screen display) language.
	Français	
	Deutsch	
	Italiano	
	Español	
	Português	
	Nederlands	
	Русский	
	Svenska	
	Dansk	
	Suomi	
	Norsk	
	Polski	
Magyar		
עברית		
Türkçe		
Ελληνικά		



(Continued on next page)

Sub-menu	Option	Description/Function
On/Off schedule	Auto On/Off	Enables/disables the Auto power on/power off options.
	Auto on hour	Powers on the photo frame automatically according to the time length you set.
	Auto on minute	
	Auto off hour	Powers off the photo frame automatically according to the time length you set.
	Auto off minute	
Display	Brightness	Sets the level of brightness.
	Contrast	Sets the level of contrast.
Photo view options	Original	Displays photos in their original aspect ratio.
	Fit to screen	Optimizes photos to fit the whole screen.
Music slideshow	On	Turns on background music in slideshow mode.
	Off	Turns off background music in slideshow mode.

Copy option	Original size	Use the original file size when copying photos or music.
	Reduce size	Use the reduced file size when copying photos or music.
Default settings	EXIT	Cancels the task.
	OK	Resets to system default settings.
Clear internal memory	EXIT	Cancels the task.
	OK	Formats the internal memory. WARNING: <i>This option will delete all the photo and music files stored on the internal memory.</i>



3.5.1 Setting an alarm

1. In the **Main Menu**, press the **LEFT** or **RIGHT** button to select the **Settings** menu.
2. Press the  button to enter the **Settings** menu.
3. Press the **DOWN/VOL—** button to select **Alarm setting**, and then press the  button.
4. Press the **LEFT** or **RIGHT** button to set the alarm to **On**.
5. Continue to adjust the alarm hour, minute, volume, tone and Day.
In the **Day** option, you can select **Everyday** or **Weekday**. When **Everyday** is selected, alarm repeats everyday, including Saturday and Sunday. When **Weekday** is selected, alarm repeats from Monday to Friday.
6. Press the **EXIT** button when finished.



NOTE

- When the alarm goes on, you can press the **EXIT** button to stop the alarm or press the  button to activate the snooze function.
- If you choose **MP3** in the **Tone** option, music stored in the built-in memory will be used as the alarm tone.
- If no music file is available in the memory, Beep tone will be used as the alarm tone.



3.5.2 Enabling auto on/off

The photo frame comes with the Programmable On/Off Time feature, making it possible to power on and off automatically according to the time you set.

1. In the **Main Menu**, press the **LEFT** or **RIGHT** button to select the **Settings** menu.
2. Press the  button to enter the **Settings** menu.
3. Press the **DOWN/VOL—** button to select **On/Off schedule**, and then press the  button.
4. Press the **LEFT** or **RIGHT** button to select **On** for the **Auto On/Off** option.
5. Continue to set the Auto On/Off time.
 - To move among entries, press the **UP/VOL+** or **DOWN/VOL—** button.
 - To adjust the time, press the **LEFT** or **RIGHT** button.
6. Press the **EXIT** button when finished.

NOTE

When the photo frame has been powered off automatically, you can press any control buttons or any buttons on the remote control to resume the system at any time. Once it reaches the scheduled Off time, the photo frame will power off automatically still.

4. General information

If your product is not working properly...

1. Read this User's Guide or the Quick Start Guide.
2. Visit our website:
www.motorola.com
3. Contact Customer Service:
 - 1-888-331-3383 in US and Canada
 - 0845 218 0890 in UK
 - (65) 68412668 in Singapore

Consumer Products and Accessories purchased in the United States, Canada, UK and Singapore.

What Does this Warranty Cover?

Subject to the exclusions and limitations contained below, Binatone Electronics International LTD. warrants the Motorola branded consumer products that it manufactures ("Products") and the Motorola branded or certified accessories sold for use with these Products that it manufactures ("Accessories") to be free from defects in materials and workmanship under normal consumer usage for the period(s) outlined below. This limited warranty is a consumer's exclusive remedy, and only applies as follows to new Motorola branded Products and Accessories manufactured by Binatone Electronics International LTD., and purchased by consumers in the United States, Canada, UK or Singapore, which are accompanied by this written warranty:

Who is covered?

This warranty covers only the first consumer purchaser, and is not transferable.



What will BINATONE ELECTRONICS INTERNATIONAL LTD. do?

BINATONE ELECTRONICS INTERNATIONAL LTD., at its sole option, will at no charge repair, replace or refund the purchase price of any Products or Accessories that does not conform to this warranty. Binatone Electronics International LTD. may use functionally equivalent reconditioned/ refurbished/ pre-owned or new Products, Accessories or parts in such repair or replacement and any Products, Accessories or parts removed or being replaced under this warranty become the property of Binatone Electronics International LTD.

What Other Limitations Are There?

ANY IMPLIED WARRANTIES OR CONDITIONS IRRESPECTIVE OF WHETHER THEY ARE IMPOSED BY LAW OR OTHERWISE, INCLUDING WITHOUT LIMITATION THE IMPLIED WARRANTIES OF MERCHANTABILITY AND FITNESS FOR A PARTICULAR PURPOSE, SHALL BE LIMITED TO THE DURATION OF THIS LIMITED WARRANTY, OTHERWISE THE REPAIR, REPLACEMENT, OR REFUND AS PROVIDED UNDER THIS EXPRESS LIMITED WARRANTY IS THE EXCLUSIVE REMEDY OF THE CONSUMER, AND IS PROVIDED IN LIEU OF ALL WARRANTIES AND MOTOROLA AND BINATONE ELECTRONICS INTERNATIONAL LTD. MAKES NO OTHER WARRANTIES OR CONDITIONS, EXPRESS OF IMPLIED. IN NO EVENT SHALL MOTOROLA OR BINATONE ELECTRONICS

INTERNATIONAL LTD. BE LIABLE, WHETHER UNDER THIS LIMITED WARRANTY OR IN CONTRACT OR TORT (INCLUDING NEGLIGENCE OR STRICT PRODUCT LIABILITY) OR OTHERWISE FOR DAMAGES OR CLAIMS IN EXCESS OF THE PURCHASE PRICE OF THE PRODUCT OR ACCESSORY, OR FOR ANY INDIRECT, INCIDENTAL, SPECIAL OR CONSEQUENTIAL DAMAGES OF ANY KIND, OR LOSS OF REVENUE, SAVINGS OR PROFITS, LOSS OF BUSINESS, LOSS OF PROGRAMS DATA INFORMATION (WHETHER CONFIDENTIAL PROPRIETARY OR PERSONAL IN NATURE OR OTHERWISE) OR OTHER FINANCIAL LOSS ARISING OUT OF OR IN CONNECTION WITH THE ABILITY OR INABILITY TO USE THE PRODUCTS OR ACCESSORIES AND BINATONE ELECTRONICS INTERNATIONAL LTD. SHALL UNDER NO CIRCUMSTANCES BE LIABLE FOR ANY CLAIMS OR DEMANDS MADE BY ANY THIRD PARTY OR MADE BY YOU ON BEHALF OF ANY THIRD PARTY TO THE FULL EXTENT THESE DAMAGES OR CLAIMS MAY BE DISCLAIMED BY LAW.

Some states, countries or jurisdictions do not allow the limitation or exclusion of incidental or consequential damages, or limitation on the length of an implied warranty, so the above limitations or exclusions may not apply to you in such states, countries or jurisdictions. This warranty gives you specific legal rights, and you may also have other rights that vary from state to state or from one country/jurisdiction to another.



Products or Accessories Covered	Length of Coverage
Consumer Products	One (1) year from the date of purchase by the first consumer purchaser of the product.
Consumer Accessories	Ninety (90) days from the date of purchase by the first consumer purchaser of the accessory.
Consumer Products and Accessories that are Repaired or Replaced	The balance of the original warranty or for ninety (90) days from the date returned to the consumer, whichever is longer.

Exclusions

Normal Wear and Tear. Periodic maintenance, repair and replacement of parts due to normal wear and tear are excluded from coverage.

Abuse & Misuse. Defects or damage that result from: (a) improper or unreasonable use, operation, storage, misuse or abuse, accident or neglect or other external cause, such as physical damage (cracks, scratches, etc.) to the surface of the product resulting from misuse; (b) your failure to follow or operation outside the usage parameters stated in the user instructions that came with the Products or Accessories; (c) contact with liquid, water, rain, extreme humidity or heavy perspiration, sand, dirt or the like, extreme heat, or food; (d) use of the Products or Accessories for commercial purposes or subjecting the Product or Accessory to abnormal usage or conditions; or (e) other acts or omissions which are not the fault or neglect of Motorola or Binatone Electronics International LTD., are excluded from coverage.

Use of Non-Motorola branded Products and Accessories. Defects or damage that result from the use of Non-Motorola branded or certified Products or Accessories or other peripheral equipment are excluded from coverage.

Unauthorized Service or Modification. Defects or damages resulting from service, testing, adjustment, installation, maintenance, alteration, or modification in any way by someone other than Motorola, Binatone Electronics International LTD. or its authorized service centers, are excluded from coverage.



Altered Products. Products or Accessories with (a) serial numbers or date tags that have been removed, altered or obliterated; (b) broken seals or that show evidence of tampering; (c) mismatched board serial numbers; or (d) nonconforming or non-Motorola branded housings, or parts, are excluded from coverage.

Communication Services. Defects, damages, or the failure of Products or Accessories due to any communication service or signal you may subscribe to or use with the Products or Accessories is excluded from coverage.

How to Obtain Warranty Service or Other Information?

To obtain service or information, please call:

- 1-888-331-3383 in US and Canada
- 0845 218 0890 in UK
- (65) 68412668 in Singapore

You will receive instructions on how to ship the Products or Accessories, the shipment of which shall be at your own risk and expense, to a BINATONE ELECTRONICS INTERNATIONAL LTD. Authorized Repair Center. To obtain service, you must include: (a) a copy of your receipt, bill of sale or other comparable proof of purchase of the Products or Accessories showing the date of purchase; (b) a written description of the problem; and, most importantly; (c) your address and telephone number.

These terms and conditions constitute the complete warranty agreement between you and BINATONE ELECTRONICS INTERNATIONAL LTD. regarding the Products or Accessories purchased by you, and supersede any prior agreement or representations, including representations made in any literature publications or promotional materials issued by BINATONE ELECTRONICS INTERNATIONAL LTD. or representations made by any agent employee or staff of BINATONE ELECTRONICS INTERNATIONAL LTD., that may have been made in connection with the said purchase.

Compliance Information

Declaration of Conformity

CE This product is in compliance with the essential requirements and other relevant provisions of Directive 2004/108/EC:
European Standard EN55022:2006 Class B, EN61000-3-2:2006, EN61000-3-3:1995/A1:2001/A2:2005 and EN55024:1998/A1:2001/A2:2003 (IEC 61000-4-2:Edition 1.2:2001-04, IEC 61000-4-3:Edition 2.1:2002-09, IEC 61000-4-4:Second edition:2004-07, IEC 61000-4-5:Edition 1.1:2001-04, IEC 61000-4-6:Edition 2.1:2004-11, IEC 61000-4-8:Edition 1.1:2001-03, IEC 61000-4-11:Second Edition:2004-03) and Australian Standard AS/NZS CISPR 22:2006 Class B.

FCC Statement

This device complies with Part 15 Subpart B of the FCC Rules. Operation is subject to the following two conditions: (1) this device may not cause harmful interference, and (2) this device must accept any interference received, including interference that may cause undesired operation.

This equipment has been tested and found to comply with the limits for a Class B digital device, pursuant to Part 15 Subpart B of the FCC Rules. These limits are designed to provide reasonable protection against harmful interference in a residential installation. This equipment generates, uses, and can radiate radio frequency energy, and if not installed and used in accordance with the instructions, may cause harmful interference to radio communications. However, there is no guarantee that interference will not occur in a particular installation. If this equipment does cause harmful interference to radio or television reception, which can be determined by turning the equipment off and on, the user is encouraged to try to correct the interference by one or more of the following measures:

- Reorient or relocate the receiving antenna.
- Increase the separation between the equipment and receiver.
- Connect the equipment into an outlet on a circuit different from that to which the receiver is connected.
- Consult the dealer or an experienced radio/TV technician for help.

WARNING

You are cautioned that changes or modifications not expressly approved by the party responsible for compliance could void your authority to operate the equipment.

FCC and Industry Canada

This device complies with Industry Canada and FCC Rules. Operation is subject to the following two conditions: (1) this device may not cause harmful interference, and (2) this device must accept any interference received, including interference that may cause undesired operation.

Canadian DOC statement

- This Class B digital apparatus complies with Canadian ICES-003.
- Cet appareil numérique de la classe B est conforme à la norme NMB-003 du Canada.

WEEE Directive



Produced after 13 August 2005. Waste electrical should not be disposed of with household waste. Please recycle where facilities exist. Check with your local authority or retailer for recycling advice.



5. Technical specifications

Screen size	10.4" diagonal TFT LCD
Aspect ratio	4:3
Panel resolution	800 (H) x 600 (V) pixels
Internal memory size	512MB
Brightness	300 cd/m ²
Contrast ratio	500:1
Viewing angle in landscape and portrait positions (Top/Bottom/Left/Right)	50° / 60° / 75° / 75°
Supported memory card types	SD, SDHC, MMC
USB Host	Supported
Loudspeakers	0.5W x 2
Power adapter	<ul style="list-style-type: none">● AC input: 100-240V; 50/60 Hz; 0.6A● DC output: 9.0V, 2A
Supported image file format	JPEG (*.jpg)
Supported audio file format	MP3 (*.mp3)
Auto rotation	Built-in tilt sensor

NOTE

Specifications are subject to change without prior notice.

6. Wall mounting instructions

Landscape wall mounting

1. Cut the illustration below and drill holes in the wall exactly as illustrated.

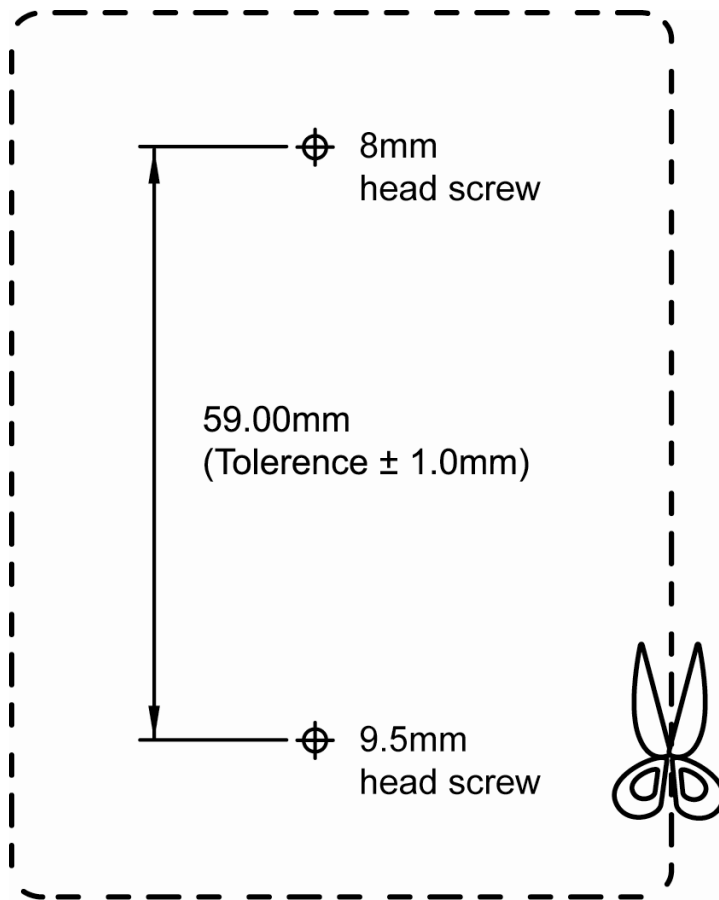

2. Insert 8mm and 9.5mm head screws (to be purchased separately) into the holes and tighten the screws. Then, align your photo frame with the screws.

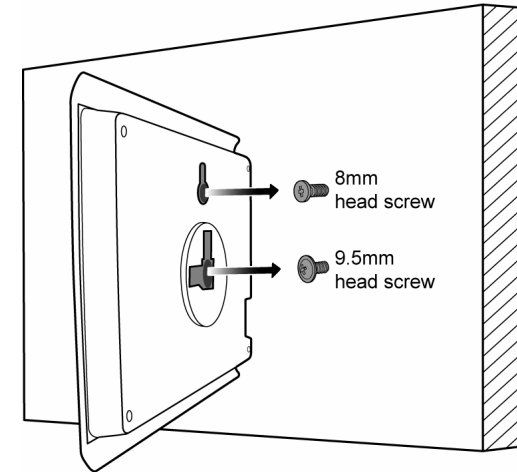

3. Mount your photo frame in landscape position on the wall.

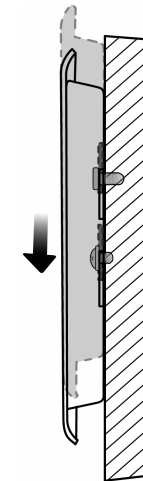

Portrait wall mounting

1. Drill a hole in the wall and insert an 8mm head screw (to be purchased separately) into the hole.
2. Align your photo frame with the screw.

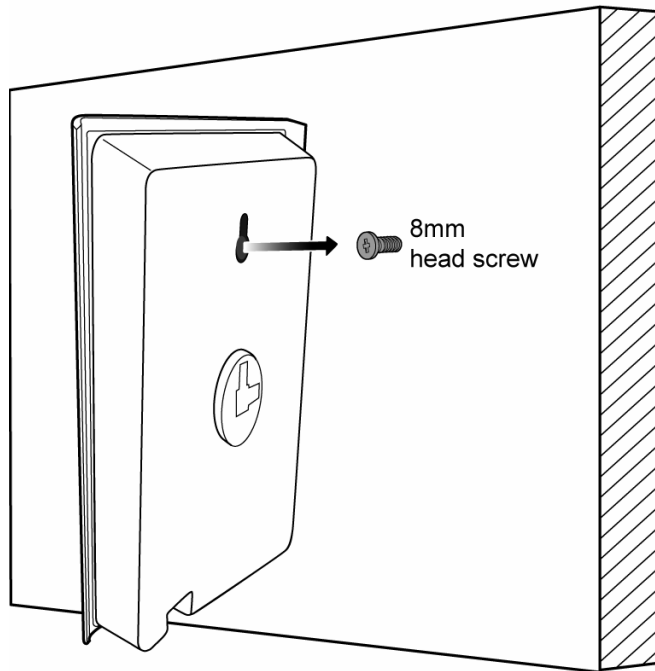

3. Mount your photo frame in portrait position on the wall.

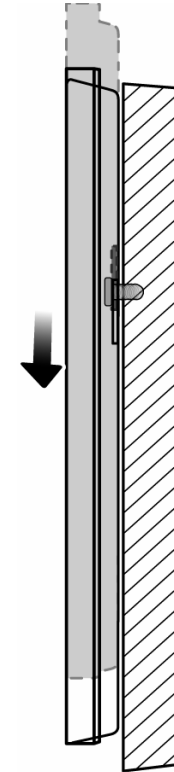



MOTOROLA

Manufactured, distributed or sold by Binatone Electronics International LTD., official licensee for this product.

MOTOROLA and the Stylized M Logo, and other Motorola trademarks and trade dress are owned by Motorola, Inc. and are used under license from Motorola, Inc. MOTOROLA and the Stylized M Logo are registered in the US Patent & Trademark Office. All other product or service names are the property of their respective owners.

© Motorola, Inc. 2009. All rights reserved.



Version 1.0

Printed in China