



MOTOROLA

COLOR LCD DIGITAL CORDLESS PHONE

User Guide



Model ME4851 Series
Digital 1.8 GHz

Congratulations on your purchase of a Motorola product!
Your Motorola Telephone at a glance:

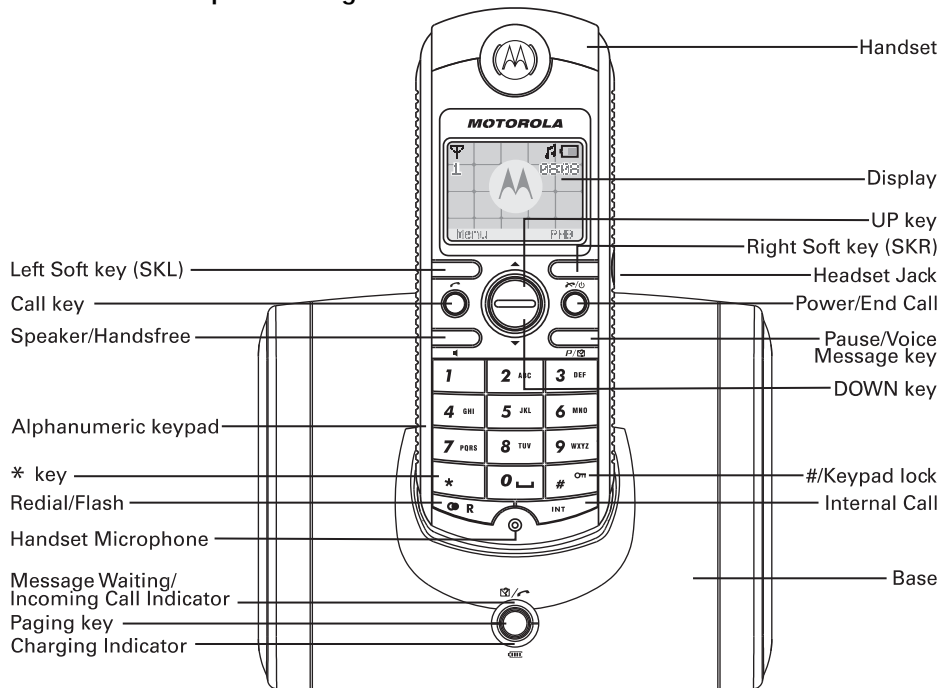

For product-related questions, please refer to the Warranty section.

Please retain your original dated sales receipt for your records. For warranty service of your Motorola Product, you will need to provide a copy of your dated sales receipt to confirm warranty status.

CE Complies with the essential protective requirements and objectives of the EC's R&TTE Directive 1999/5/EC; EC Low Voltage Directive 72/23/EEC; EC EMC Directive 89/336/EEC

Copyright © 2004 Motorola, Inc.

All rights reserved. No part of this publication may be reproduced in any form or by any means or used to make any derivative work (such as translation, transformation or adaptation) without written permission from Motorola, Inc.

Motorola reserves the right to revise this publication and to make changes in content from time to time without obligation on the part of Motorola to provide notification of such revision or change. Motorola provides this guide without warranty of any kind, either implied or expressed, including but not limited to, the implied warranties of merchantability and fitness for a particular purpose. Motorola may make improvements or changes in the product(s) described in this manual at any time.

MOTOROLA, the Stylized M Logo, and PhoneWrap are registered in the U.S. Patent and Trademark Office. All other product or service names are the property of their respective owners.

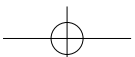

Contents

Welcome	1	Using the Telephone	16
Contents	3	Switching the Handset On / Off	16
Important Safety Instructions	5	Making External Calls	16
Installation Guidelines	6	Handset Range	16
Technical Amendments	7	Direct dialing	17
Installation	8	On-hook dialing	17
Package Contents	8	Using the Handsfree Speakerphone ..	17
Setting up the Base Station and		Make a handsfree call	17
Charger Unit	8	Switch to handsfree during a call ..	18
Connecting the Base Station and		Taking Calls	18
Mains Adaptor	9	Handset is in the Base Station/ charger (auto-answer)	18
Connecting the Charger Unit	10	Handset is not in the Base Station/charger	18
Preparing the Handset(s)	10	Prefix Dialing	18
Inserting and Charging the Batteries ..	10	Dialing from the Phone Book	19
Low Battery Warning	11	Access a Call Waiting Line/Holding and transferring calls (PABX)	19
Attaching a Headset	11	Calling with More than One Handset ..	19
Technical Data	11	Making Internal Calls	20
Telephone Features	12	Receiving Internal Calls	20
Control Buttons	13	Transferring/Forwarding a Call to another Handset	20
Display Icons	14	Teleconference	21
Menu Icons	14	Paging Handsets	21
Display Backlight	14	Muting the Microphone	21
Menu Structure	15	Changing the Handset Volume	22
Navigating the Menu	15	Key lock	22
		Shortcut Keys	22
		Using the Menu	23

Contents

Phone Book Menu	23	Selecting the LCD Mode	43
Storing Entries	23	Resetting your Handset to the	
Storing Number in standby mode	25	Default Settings	43
Searching Number in Phone Book	25	Handset default Settings	44
Phone Book Groups	26	Base Setting Menu	45
Speed Dial Numbers	27	Changing the Ringer Melody	45
Check Phone Book Capacity	28	Switching the Base Ringer On/Off	45
Emergency Call Numbers	29	Priority Call Alert	45
Area Code	29	Changing the Dial Mode	46
Call Log Menu	30	Registering Additional Handsets	47
Viewing the Calls Log	30	De-register a Handset	48
Saving Call Log Number		Select a Base to Use	48
to Phone Book	32	Changing the PIN Code	49
Deleting a Call Log Number	33	Changing the Flash Time	49
Deleting All Call Log Entries	33	Resetting to Default Settings	50
Timer Menu	33	Function Menu	50
Set Date and Time	33	Games	50
Set the Alarm	34	Walkie Talkie Mode	52
Silence the Alarm When it Sounds	35	Using the Wireless Headset	
Handset Settings Menu	35	Preparing wireless headset for use	54
Changing the Ringer Melody	35	Registering wireless headset to	
Changing the Ringer Volume	36	another base	54
Switching the Ringer On/Off	36	Basic Operation	56
Pre Fix Setting	37	Wireless headset lights and alert tones	57
Call Barring	38	Quick Reference	59
Message Waiting	39	Phone Book	60
Changing the Display Wallpaper	40	Calls log	61
Changing the Display Language	40	Timer Menu	61
Changing the Display Contrast	41	Handset Settings	62
Switching Key Tones On/Off	41	Base Settings	64
Switching Auto Answer On/Off	42	Function	66
Giving the Handset a Name	42	Warranty	67

Important Safety Instructions

Follow these safety precautions when using your cordless phone to reduce the risk of fire, electric shock and injury to persons or property:

Reduce risk of fire and shock by:

1. Keep all slits and openings of the phone unblocked. Do not set the phone on a heating register or over a radiator. Ensure that proper ventilation is provided at the installation site.
2. Do not use while wet or while standing in water.
3. Do not use this product near water (for example, near a bath tub, kitchen sink, or swimming pool).
4. Do not allow anything to rest on the power cord. Place the power cord so that it will not be walked on.
5. Never insert objects of any kind into the product slits as that may result in fire or shock.
6. Unplug this product from the wall outlet before cleaning. Do not use liquid cleaners or aerosol cleaners. Use a damp cloth for cleaning.
7. Do not disassemble this product. If service or repair work is required, contact the Warranty Service phone number found in the back of this user's guide.
8. Do not overload wall outlets and extension cords.
9. Avoid using during an electrical storm. Use a surge protector to protect the equipment.
10. Do not use this cordless phone to report a gas leak, especially if you are in the vicinity of the gas line.

Unplug this cordless phone immediately from an outlet if:

- The power cord or plug is damaged or frayed.
- Liquid has been spilled into the product.
- The product has been exposed to rain or water. Do not retrieve the handset or base until after you have unplugged the power and phone from the wall. Then retrieve the unit by unplugged cords.
- The product has been dropped or the cabinet has been damaged.
- The product exhibits a distinct change in performance.

Installation Guidelines

1. Read and understand all instructions and save them for future reference.
2. Follow all warnings and instructions marked on the product.
3. Do not install this product near a bath tub, sink or shower.
4. Operate this phone using only the power source that is indicated on the marking label. If you are unsure of the power supply to your home, consult with your dealer or local power company.
5. Do not place this product on an unstable cart, stand or table. This product may fall, causing serious damage to the product.
6. Adjust only those controls that are covered by the operating instructions. Improper adjustment of other controls may result in damage and will often require extensive work to restore the product to normal operation.
7. Clean this product with a soft, damp cloth. Do not use chemicals or cleaning agents to clean this phone.

8. Use only the power supply that came with this unit. Using other power supplied may damage the unit.
9. Because cordless phones operate on electricity, you should have at least one phone in your home that isn't cordless, in case the power in your home goes out.
10. To avoid interference to nearby appliances, do not place the base of the cordless phone on or near a TV, microwave oven, or VCR.

Technical Amendments

These Operating Instructions are issued for information purposes.

Their content is not subject of a contract.

All indicated data are merely nominal values. The described equipment and options may differ depending on requirements which are specific to each country.

This device is dedicated to be used in the analog public switched telecommunication network (PSTN).

Package Contents

	ME4851-2 Single Pack	ME4851-3 Twin Pack	ME4851- 4 Triple Pack
Base station	1	1	1
Handset	1	2	3
Mains Adaptor	1	2	3
Telephone Line Cord	1	1	1
Rechargeable Batteries (type AAA rechargeable)	2	4	6
Charger Unit (Handset)	0	1	2
Wireless Headset	1	1	1
Charger Unit (Wireless Headset)	1	1	1
Rechargeable Batteries (type Li-Poly)	1	1	1
Wireless Headset Adaptor	1	1	1
User's Guide	1	1	1

Please check the contents of the package carefully. If something is missing or has become damaged in transit, you should NOT use the telephone.

In such a case you should return to the dealer with your sales receipt or contact the Motorola's distributor directly. (For details, please refer to the Warranty section.)

Note: Retain the packaging of your appliance to prevent it from being damaged should you ever need to return it.

Setting up the Base Station and Charger Unit

Place the base station and charger unit in an easily accessible location near to a mains power socket. Make sure that the location is stable and flat and that the surface is non-slip. Make sure that all cables can be routed so as to prevent people tripping over them. Furthermore, avoid placing the base station and charger unit too close to other electronic appliances such as microwaves, PCs or HiFis, for example.

Connecting the Base Station and Mains Adaptor

1. Feed the mains power adaptor cord and the telephone line cord through the small hole in the base stand as shown.
2. Insert the telephone line cord into the corresponding socket on the base station.
3. Connect the mains power adaptor plug in the corresponding socket on the underneath of the base station.
4. Attach the base stand to the main part of the base:

Insert the 2 small plastic tabs on the stand into the 2 upper slots on the base (as shown).

Holding the stand with one hand on each of the 2 clips, gently squeeze the clips inwards and down into the lower slots on the base (as shown). The stand will click into place. Check the stand is secure before placing on your chosen surface.

5. Connect the mains power adaptor to the mains wall socket and switch the power on.
6. Connect the telephone line cord to the telephone socket.
The base station is now ready for use.



Note: The base station does not have a power switch.
Only use the mains adaptor supplied with your phone.

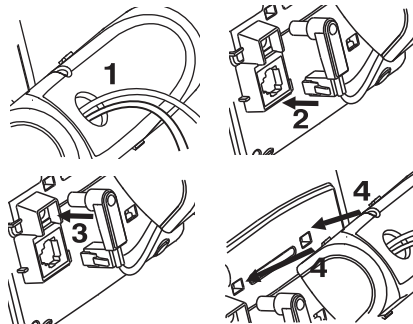

Connecting the Charger Unit

Plug the mains adaptor into the wall socket . The charger unit is now ready to use.

Preparing the Handset(s)

Inserting and Charging the Batteries

Open the battery compartment, by pushing downwards on the cover.
Insert the 2 x AAA (600mAh/1.2V) Ni-MH re-chargeable batteries supplied, observing the correct polarity.

CAUTION : PLEASE DO NOT USE ALKALINE OR NON- RECHARGEABLE BATTERIES. IT MAY CAUSE PERMANENT DAMAGE TO THE UNIT AND VOID THE WARRANTY.



If the batteries are inserted incorrectly the handset will not operate and there is also a possibility that the handset may become damaged.

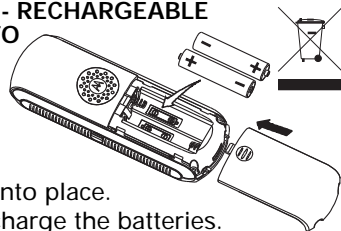

Push the battery cover back on until you hear it click into place.

Place the handset in the base station/charger unit to charge the batteries.

A confirmation beep and the charging indicator confirm that the handset is charging.

Note: Before first use, the batteries should be allowed to charge for at least 16 hours, without interruption. If possible, only take the handset out of the base station when charging is complete. This will help to guarantee optimum operation.

Note: To ensure no interruptions during the initial charging period, you may prefer to connect the telephone line cord after charging so as not to be disturbed by any incoming calls.

Note: To ensure the battery charging properly, clean the charging contacts on the handset and charger with a soft, dry cloth once a month. Clean more often if the unit is subject to grease, dust or high humidity.

LOW BATTERY WARNING

If the handset batteries are low and need charging you will hear a beep every 30 seconds and the  icon will be displayed.

Attaching a Headset



Note: A headset is not included as standard.

You can connect a headset to your handset.

Lift the small rubber flap on the right side of the handset to reveal the headset socket. Connect the jack plug into the jack socket.

With a headset connected the handset microphone and receiver loudspeaker are switched off and all communication is via the headset earpiece and mouthpiece.

Technical data

Receiver impedance :	32 ohm
Microphone impedance :	2.2K ohm
Receiver output power :	20mW
Plug :	2.5mm headset jack plug
Microphone sensitivity :	-42dBV/pa

Telephone Features

Congratulations on your purchase of this high quality, cordless telephone set.

The set offers the following features:

- Digital sound quality (DECT)
- 4K Colour alphanumeric display with icons
- 16 Polyphonic ringtones
- Phone book for 80 names, each with 3 contact numbers
- 4 Wallpapers (exclusive to Motorola)
- Handsfree/Headset operation
- Caller ID* function with 40 name/number call log
- Caller ID on Call Waiting (dependent on network)
- 11 Display languages
- Walkie Talkie Function between Handsets
- Backlit LCD with power save mode
- 20 Last number redial
- Alarm
- 2 Games - Snake and Guess Number
- Microphone mute
- Low battery warning tone
- Keypad lock
- GAP compatible - Operation of up to 6 handsets with ME4851 base Use ME4851 handset on up to 4 bases
- Teleconference +
- Internal, free communication between handsets +
- Priority call alert
- Message waiting alert
- Emergency call number
- 9 Speed dial numbers
- Separate ringtones for internal/external/group and page calls
- 5 Earpiece volume levels
- 5 Ringer volume levels and ringer mute
- 5 Base ringtones
- Pre-fix dialling
- Display clock
- Handset name
- Call duration on display
- Automatic call answering on/off
- Key input tone on/off
- Paging function from base station to handset
- Programmable number barring
- Up to 100 hours standby
- Up to 10 hours continuous talk time
- Recall/Pause/Hold
- Tone and pulse dialling modes

* More than one handset required.

* User must subscribe to service via network provider

DECT : Digitally Enhanced Cordless Telephone D Standard for cordless telephones.





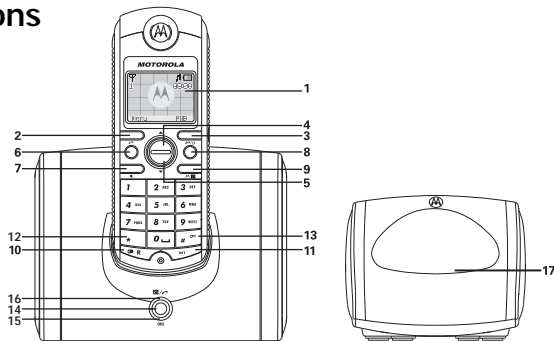





GAP : Generic Access Profile D Standard for the Interoperation of handsets and base stations from other manufacturers.

Control Buttons









1. Display
2. Left Soft Key (SKL)
Press from standby to view the menu
Press to select and confirm display items.
Use to mute/unmute the microphone.
In games mode, press to pause/play.
3. Right Soft Key (SKR)
Press from standby to access the Phone Book.
Press to go back to the previous menu.
Press to delete an incorrect character/digit.
4. Up Key
Use to scroll up through the menu/display options.
Shortcut key to access Missed Calls Log.
5. Down Key
Use to scroll down through the menu/display items.
Shortcut key to access Received Calls Log.
6. External Call Key
Use to make an external call.
7. Handsfree/Speaker Key
Use to activate/de-activate handsfree.
8. OFF Key
Use to end a call.
Press to return to standby mode.
Press and hold to switch the power on/off.
9. Pause/Voice Message Key
When storing a number, press and hold to enter a pause.
Shortcut key to activate voice mail in standby mode.
10. Redial/Flash Key
Access a Call Waiting Line / Hold and transfer calls when connected to PABX
11. INT Key
Press to make an intercom call.
Use to put an external call on hold.
12. * Key
Press to enter an asterisk.
Shortcut key to switch from Pulse to DTMF dialing mode.
13. #/Keypad Lock Key
Press to enter a hash.
Shortcut key to lock/unlock the keypad
14. Page (Find Handset) Key
Press to locate a missing handset/page all handsets registered to the base.
15. Charging Indicator
Illuminates when handset is charging in the base station.
16. Message Waiting/Incoming call indicator
Illuminates when handset is connected to a call in the base station.
17. Charge contacts

Display Icons

	Signal icon	Disappear if the handset moves out of communication range with the base.
	Key lock icon	Keypad lock is active.
	Line in use icon	Indicates that the line is in use.
	Alarm icon	Alarm is set.
	Ring icon	External ring volume is set to on.
	Battery icon	Shows the battery charge level.
	No ring icon	External ring volume is set to off.
	No Line icon	Base not connected with PSTN.
	Mic mute icon	Microphone is muted.
	Message waiting icon	Indicates that there is message waiting.

Menu Icons

	Phonebook icon	Phonebook in use.
	Call log icon	Call log in use.
	Timer icon	Time being set.
	Handset settings icon	Used to access handset settings.
	Base settings icon	Used to access base settings.
	Function icon	Used to indicate other available functions.

Display Backlight

The backlight on your handset display comes on when any key is pressed. The light remains on for 15 seconds after the last button press if you selected 'power save mode' or for 30 seconds if you selected 'extended mode'. The backlight also comes on when you receive an incoming call (and goes out 3 seconds after the call ends) and when the alarm time is up (the light comes on for 5 seconds).

Menu Structure

- ☐ Phone book
 1. Search
 2. Add
 3. Group
 4. Speed Dial
 5. Check
 6. Emergency Call
 7. Area Code
- ☐ Call log
 1. Missed Call
 2. Received Call
 3. Dialed Call
 4. Delete
- ☐ Timer
 1. Clock
 2. Alarm
- ☐ Handset settings
 1. Ring Type
 2. Ring Volume
 3. Ring On/Off
 4. Pre Fix
 5. Outgoing Call Bar
 6. Message Waiting
 7. Wallpaper
 8. Language
 9. Contrast
 10. Key Tone
 11. Auto Answer
 12. Handset Name
 13. LCD Mode
 14. Default
- ☐ Base settings
 1. Base Ring Tone
 2. Base Ring On/Off
 3. Priority Call Alert
 4. Dial Mode
 5. Register
 6. De-register
 7. Select Base
 8. System PIN
 9. Flash Time
 10. Default
- ☐ Function
 1. Games
 2. Walkie Talkie

Navigating the menu

In standby mode:

Press the **SKL** key to open the main menu and display the first menu option.



When you access a sub-menu the relevant menu icon will be displayed.

Press the ▲ or ▼ key to scroll through and display all the available sub-menus.

Press the **SKL** key to select the currently displayed option. Or

Press the **SKR** key to go back to the previous display.

Using the Telephone

Note: If the handset is in the base station or charger unit, only the  key and  key will function.

Lift the handset out of the base station/charger unit for use.

Switching the handset On/Off

When the handset is put in the base station/charger unit it switches on automatically and charges up.

Allow the batteries to charge for 16 hours without interruption before first use.

To switch the handset off:

1. In ON mode, press and hold the  key for 2 seconds.

To switch the handset on:

1. In OFF mode, press and hold the  key for 2 seconds.

Making External Calls

There are two ways to dial a number: direct dialling or on-hook dialling.

Whenever the line is in use the  icon is displayed.

If another internal handset is already engaged on an external call, the  icon will be displayed. No further calls can be made until this call is ended.

Handset range

If the handset moves out of communication range with the base station, the display will show Out Of Range and the  icon will disappear.

Direct dialling



1. Press the  key and wait for the dialling tone.
2. Dial the telephone number and complete the call.

When the call is connected, the call duration will be displayed and will remain in the display until 3 seconds after the call is ended.

The call timer format is HH:MM:SS.

3. Press the  key to end the call.



On-hook dialling (pre-dialling)

1. Dial the telephone number.
2. Delete any incorrect digits by pressing the **SKR** key.
3. Press the  key. The displayed number is dialled.
4. To end the call, press the  key.





Hands-free Mode

There are two methods with which to have telephone conversations in hands-free mode ,namely using direct dialling or by switching over during the call.

Direct dialling

1. Dial the call number and press the  key to start dialling.
2. Carry out the conversation.
3. Press the  key to end the call.

Switching During a Call

1. Dial the call number and press the  key to start dialing.
2. Carry out the conversation.
3. Press the  key to switch hand-free mode on or off.
4. Press  or  key to adjust the handset volume.
5. Press the  key to end the call.

Taking calls

When an external call is received, all registered handsets ring and the LCD backlight will be on during ringing. The display shows Incoming call.



The green incoming call light on the base flashes.

Note: If you have subscribed to caller ID, the caller's name or number will be shown (if available from the network).



Handset is in the base station/charger (auto-answer):

If auto-answer is set to on, the line will be automatically connected when you lift the handset from the base/charger.

1. Lift the handset to answer the call.

Note: If auto-answer is set to off, lift the handset and press the  key or the  key to answer the call.

Handset is not in the base station/charger:

1. Press the  key or the  key to answer the call.

Prefix Dialling

When prefix dialling is set to ON, the prefix number that you set will be dialled out first whenever you make an external call. The prefix can be a number up to 5 digits.

You can use the prefix memory to store an area code that you frequently use, for example 0207 or 08457, to save you dialling it each time you make a call.

See page 37 for details on how to store a prefix number.



Dialling from the Phone Book

Note: To store a number in the Phone Book, see "Storing entries" on page 23.

In standby mode:

1. Press the **SKR** key to enter the phone book.

Note: If the phonebook is empty, No Records will be displayed for 2 seconds.

2. The first entry in the phone book is displayed. Press the ▲ or ▼ key to display the entry you want.
3. Press the  key to dial the number.
4. Press the  key to end the call.

Access a Call Waiting Line/Holding and transferring calls (PABX)

When on an external call, press **OR** key to access a Call Waiting Line when you hear the call waiting prompt signal. Press **OR** key again to toggle between the two calls.

When on an external call (PABX line)

1. Press **OR** key to put the call on hold.
2. Dial the number of the extension.
3. Press **OR** key again if you would like to take back the call, or  to transfer the call.

Note: If several handsets are registered on the base station and a call should be put on hold or transferred, press the **INT** key instead of **OR** .



Calling with More Than One Handset

Note: To make/receive internal calls, transfer calls or hold a teleconference you need to have more than one handset registered to your base station.

Making Internal Calls



With more than one handset registered to the same base as you, you can make internal calls between handsets.

To call another internal handset:

1. Press the **INT** key.
2. Press the ▲ or ▼ key to display the handset you want to call and press the  key or  key.
The called handset will ring and show the caller's handset number
When the other handset answers hold your conversation.
3. Press the /⏻ key to end the call.



Receiving Internal Calls

When you receive an internal call, the handset will ring and show the calling handset's number, and the backlight will come on for 15 seconds after call is picked up by the handset.

1. Press the  key or the  key to answer the call.
2. Press the /⏻ key to end the call.

Transferring/Forwarding a Call to Another Handset

To transfer/forward an external call to another internal handset.

1. Press the **INT** key to put the external call on hold.
2. Enter the internal handset number you want. The called handset will ring.
3. When the handset answers, press the /⏻ key to transfer the call. Or
If the called handset does not answer, press the /⏻ key to forward the call.
After 30 seconds the call will ring back at your handset if the call is still not answered. Press the  key to speak to the caller.

Teleconference

If you are already on an external call, it is possible to include another internal handset in the conversation and hold a three-way conference call.

1. Press the **INT** key to put the external call on hold.
2. Enter the internal handset number you want to include in the call.
The called handset will ring.
3. When the handset answers, press the **3** key to begin the teleconference.
4. Either internal handset can press the /⏻ key at any time to leave the teleconference.
The other internal handset will remain connected to the external call.

Paging Handsets

If you cannot locate a handset you can use the page key on the base to help find it.

1. Press the Page key on the base.
All handsets registered to the base will ring and the display on each handset will show Paging.
2. To stop the paging ring, press the Page key on the base again, or press any key on the handset.

Note: All paged handsets will stop ringing if any key on the handset or page key on the base is pressed.

Muting the Microphone

During a call (internal or external), you can mute the microphone so your caller cannot hear you while you speak privately to someone else in the room. The  icon is displayed when the microphone is muted.

During a call:

1. Press the **SKL** key to mute/unmute the microphone.

Changing the Handset Volume

You can adjust the handset volume during a call (external or internal), the volume level is displayed. There are 5 different volume levels.

During a call:

1. Press the ▲ or ▼ key to adjust the handset volume.

Key Lock



You can use the key lock to prevent accidental button presses activating the handset. When the key lock is on, the  icon is displayed.

You will still be able to make calls to the emergency numbers when the key lock is on.

In standby mode:

1. Press and hold the #  key to lock/unlock the keypad.

Note: When the key lock is on, the # and  keys will still function and you will be able to accept an incoming call and turn off the alarm.

Shortcut Keys

The ME4251 telephone has three shortcut keys: ▲, ▼, and P/☑ .

When pressed in standby mode, each key will give you automatic access to a different telephone function.

In standby mode:

Press the ▲ key to view the missed call log.

(See page 30-32 for more information on the missed call log.)

Press the ▼ key to view the received call log.

(See page 30 for more information on the received call log.)

press P/☑ key to access message waiting server.

(See page 39 for more information on the message waiting server.)

Using the Menu

The menu can only be accessed from standby mode.

Navigating your way around the menu

For the full menu structure and information on navigating your way around the menu, see page 15.

In this section you will find instructions on how to use the following menus: Phone book, Call log, Timer, Handset settings, Base settings and Function menu.

PHONE BOOK MENU

When using the phone book, the  icon will be displayed.

The phone book stores up to 80 contact names - for each contact name you can store 3 different contact numbers, for example: home, office and mobile numbers.

Once you have stored your names and numbers, you can sort your contacts into caller groups and assign each caller group a different ringtone. Caller groups make searching for contacts easier and you can tell if a call is, for example, from a friend or a work colleague just by hearing the ringtone. There are 6 pre-set caller groups: VIP, Business, Family, Friends, School and Others. You can edit the caller group names if you wish.

Storing Entries

There are two ways to store a phone book entry: Using the Phone book menu and from standby mode.

Using the phone book menu:

1. Press the **▲** or **▼** key until Add is displayed and press the **SKL** key to select.

Note: If the phone book is full, Memory Full will be displayed for 2 seconds, then the display reverts to the previous menu screen.

2. Enter a contact name (max. 16 characters) and press **SKL** to confirm.

Entering Names and Numbers

To enter characters, press the relevant key the corresponding number of times according to the position on the key. For example, to enter an L, press the **5** key three times or to enter a B press the **2** key twice.

Delete incorrect digits by pressing the **SKR** key.

Press the ***** key to switch between lower/upper case and number only entry.

If 2 consecutive characters are on the same key, enter the first character, then wait for the cursor to move to the right before trying to enter the next character.

Press the **1** key or **#** key repeatedly to enter punctuation symbols.

Press the **0** key twice to enter a space.

3. Enter the first number for this name (max. 24 digits) and press **SKL** to confirm.

4. Repeat point 3 to enter 2 further numbers for the name.

Or

If you do not want to enter any further contact numbers, press **SKL** twice to go directly to the 'Set Group' menu.

Entering a Dialling Pause (P)

If the telephone is connected to a switchboard/PBX network, it may be necessary to insert a pause in the dialling sequence.

When entering a number, press and hold the **P/☑** key where a pause is required. A "P" will be displayed.

5. Press **▲** or **▼** to select a caller group and press **SKL** to select.

Save ok is displayed and then the list of phone book entries is displayed.

6. Press the **☒/⏻** key to return to standby mode.

Storing a number from standby mode:

1. Enter the telephone number you want to store and press **SKL** to save the number.
2. Select a location to store the number (e.g. Number 1) and press the **SKL** key to confirm.
3. Enter the name and press the **SKL** key.
4. Press ▲ or ▼ to select the caller group where you want to store the name/number and press the **SKL** key to confirm.

Save ok is displayed and then return to standby mode.

5. Press the  key to return to standby mode.

Search for a Number in the Phone Book

Any time during a call, you can press **SKR** to view the phonebook.

In the phone book menu:

1. Search is displayed, press the **SKL** key to select.
2. Enter the first letter of the name you want and press the **SKL** key.

The first phone book entry beginning with this letter will be displayed.

Note: For quick searching, you can enter more than one letter of the name you want.

Note: If the phone book is empty, Empty will be displayed.

3. Press ▲ or ▼ to search for the exact entry and press **SKL** to see the entry details.

Note: To change the details of the displayed entry

Press ▲ or ▼ to scroll to the part of the entry you want to edit (for example, scroll to the first telephone number) and press the **SKL** key. The display will show eg. Edit No. 1, press the **SKL** key to confirm. Edit the name/number, using the **SKR** key to delete incorrect digits/characters and the keypad to enter new ones. Press the **SKL** key to confirm and save the edited details.

4. Press the  key to return to standby mode.

Phone Book Groups

Your phone book names and contact numbers are stored in smaller, more manageable caller groups. There are six pre-set groups - VIP, Business, Family, Friends, School and Others.

To display the contacts stored in a particular group:

In the phone book menu:

1. Press the ▲ or ▼ key until Group is displayed and press the **SKL** key to select.
2. Press the ▲ or ▼ key to display the name of the group you want and press **SKL**.
3. Press the ▲ or ▼ key to display either View or Edit Name.

If you select View:

The list of entries stored in the chosen group will be displayed. Use the ▲ or ▼ key to scroll to the entry you want, and the **SKL** key to view details for the displayed entry.

To change the details of the displayed entry

Press the ▲ or ▼ keys to scroll to the part of the entry you want to edit (for example, scroll to the first telephone number) and press the **SKL** key. The display will show (for example) Edit No. 1 , press the **SKL** key to confirm. Edit the name/number, using the **SKR** key to delete incorrect digits/characters and the keypad to enter new ones. Press the **SKL** key to confirm and save the edited details.

If you select Edit Name:

You can change the name of the group to another name of your choice.

Use the **SKR** key to delete incorrect characters/digits and enter new ones using the keypad. When the group name is edited, press **SKL** to confirm. Save ok is displayed.

4. Press the  key to return to standby mode.

Speed Dial Numbers

Your Motorola telephone has 9 speed dial keys (keys 1- 9). You can select any of the numbers stored in the phonebook and save them on a speed dial key. Once stored, from standby mode you can press and hold the speed dial key you want and the number will be dialled out automatically.

Speed dial numbers can be up to 24 digits.

Store a Speed Dial Number

In the phone book menu:

1. Press the ▲ or ▼ key until Speed Dial is displayed and press the **SKL** key to select.
Key 1 is displayed with details of the stored name/number
or
Empty is displayed if no name/number has been allocated.
2. Press the ▲ or ▼ key to display the speed dial key you want and press the **SKL** key to confirm.
3. Phone Book is displayed, press the **SKL** key to access the phone book list.
4. Press the ▲ or ▼ key to select the name of the contact that you want to store on the speed dial key and press the **SKL** key to confirm.
Save ok is displayed, then the details now saved on the speed dial key.
5. Press the  key to return to standby mode.

Delete a Speed Dial Number

In the phone book menu:

1. Press the ▲ or ▼ key until Speed Dial is displayed and press the **SKL** key to select.
2. Press the ▲ or ▼ key to display the speed dial key you want and press the **SKL** key to confirm.
3. Press the ▼ key to select Delete then press the **SKL** key.
Delete entry? is displayed.
4. Press the **SKL** key to confirm. Deleted is displayed.
5. Press the /⏻ key to return to standby mode.

Check Phone Book Capacity

You can use the 'Check' sub-menu to check how many phone book entries you have stored.

In the phone book menu:

1. Press the ▲ or ▼ key until Check is displayed and press the **SKL** key to select.
2. The display will show, for example, Used 25 Total 80.
Where 25 phone book locations have been used, and 55 are still available to store new contact details.
3. Press the /⏻ key to return to standby mode.

Note: If the phone book is empty Empty will be displayed.

Emergency Call Numbers

You can store 4 emergency call numbers which can be dialled out at any time even when call restrictions are set (for example, if the keypad is locked or call barring is set).

Each emergency number can have a maximum of 5 digits.

Example: If you set 123 as an emergency number - only number 123 can dial out with call restrictions set.



If you dial any of the emergency numbers manually (instead of using the phone book) and the keypad lock is on or call barring is set, they will still be dialled out.

In the phone book menu:

1. Press the ▲ or ▼ key until Emergency Call is displayed and press the **SKL** key to select.
2. Press the ▲ or ▼ key to select one of the emergency number locations and press the **SKL** key to confirm.
3. Enter the emergency number up to 5 digits and press the **SKL** key to confirm. Save ok is displayed.

Note: To edit an existing emergency number, use the **SKR** key to delete digits and the keypad to enter new ones.

4. Press the  key to return to standby mode.

Area Code

If the area code is set, when you make an external call using the on-hook dialling (pre-dial) mode, if you enter the area code in the former digits, the area code will be cut and will not be dialled. For example, if the area code is 0755, and you enter 0755123456, only 123456 will be dialled.

The area code can be a maximum of 5 digits.

In the phone book menu:

1. Press the ▲ or ▼ key until Area Code is displayed and press the **SKL** key to select.
2. Press the **SKL** key again, then enter an area code (up to 5 digits) and press the **SKL** key to confirm. Save ok is displayed.
3. Press the  key to return to standby mode.

Call Log Menu

There are three types of call log: Missed Call, Received Call, and Dialed Call. Each log can contain up to 20 records.

When using the call log the  icon will be displayed.

- Unanswered calls/calls that have been received in your absence are stored in the Missed calls log.
- Calls you have answered are stored in the Received call log.
- Calls you have made are stored in the Dialed call log.

Viewing the Call Logs

Note: If there are no calls stored in a call log, Empty! will be displayed and then the display will automatically return to the main menu.

Note: The max number of digits for a stored call log number is 24.

You can view the call logs using the menu or using the shortcut keys.

If you have new calls in the Missed call log you will also be able to view them from standby mode.

Viewing the call logs using the menu:

In the calls log menu:

1. Press the ▲ or ▼ key to display the call log you want and press the **SKL** key to select.
2. Press the ▼ key to scroll and view all call log entries.
3. With a call highlighted, press the **SKL** key to view the call details.
For each call, the caller's number and date and time of the call are displayed.
If the caller's number is stored in the phone book and an exact name/number match is found, the caller's name will also be displayed.
4. Press the **SKR** key to return to the calls log and view the other calls.
5. Press the  key to return to standby mode.

Viewing the call logs using the shortcut keys:

From standby mode:

1. Press the ▲ key to display the Missed calls log.
Or
Press the ▼ key to display the Received calls log.
Or
Press the **OR** key to display the Dialed calls log.
2. Press the ▼ key to scroll and view all call log entries.
3. With a call highlighted, press the **SKL** key to view the call details.
For each call, the caller's number and date and time of the call are displayed.
If the caller's number is stored in the phone book and an exact name/number match is found, the caller's name will also be displayed.

4. Press the **SKR** key to return to the calls log and view the other calls.
5. Press the /⏻ key to return to standby mode.

Viewing the missed call log from standby mode:

When there are calls in the Missed call log, the standby display shows, for example, 2 Missed Calls.

1. Press the **SKL** key to view the details of the most recent missed call.
The caller's number (and name if an exact name/number match is found in the phone book) and date and time of the call are displayed.
2. Press the ▼ key to scroll and view all missed calls.
With a call highlighted, press the **SKL** key to view the call details.
Press the **SKR** key to return to the calls log and view the other calls.
Note: If a caller has rung on more than one occasion, each call will be listed with the different times they called.
3. Press the /⏻ key to return to standby mode.

Saving a Call log Number to the Phone Book

With the call details displayed:

1. Press the **SKL** key, Save is displayed.
2. Press the **SKL** key to confirm.
3. Press the ▲ or ▼ key to choose a location to store the number (e.g. Number 1) and press the **SKL** key.
4. Enter a name and press the **SKL** key to confirm and store the entry.
5. Press the /⏻ key to return to standby mode.

Deleting a call log number

With the call details displayed:

1. Press the **SKL** key, then press the ▼ key to highlight Delete.
2. Deleting is displayed briefly, then Deleted!. The display then reverts to show the next calls log entry.
3. Press the  key to return to standby mode.

Delete all Calls Log Entries

In the calls log menu:

1. Press the ▲ or ▼ key to display Delete and press the **SKL** key .
2. Press the ▲ or ▼ key to highlight the calls log you want to delete or highlight Delete All to delete the entries from all 3 call logs and press the **SKL** key to confirm. Deleting is displayed briefly, then Empty!
3. Press the  key to return to standby mode.

TIMER MENU

The timer menu lets you set the handset clock and set an alarm.

When using the timer the  icon will be displayed.

Set the Date and Time

You can use the clock menu to set the correct date and time on your handset.

Your ME4851 telephone uses the 24 hour clock.

In the Timer menu:

1. Press the ▲ or ▼ key to display Clock and press the **SKL** key to confirm.

2. Enter the date using 2 digits for the day, 2 for the month and 4 for the year and press the **SKL** key to confirm.
Example, for 17th July 2005: enter 1, 7, 0, 7, 2, 0, 0, 5.
3. Enter the time using 2 digits for the hour and 2 for the minute and press the **SKL** key to confirm.
Example, for 2:45pm: enter 1, 4, 4, 5.
Set ok is displayed.
4. Press the  key to return to standby mode.





Set the Alarm

You can set the alarm on your handset to ring once, to ring at the same time every day, to ring weekday at a set time, or you can switch the alarm Off.

You can select from 16 different ringer melodies and 5 different ring volumes for the alarm.

When the alarm is set the  icon is displayed.

In the Timer menu:

1. Press the  or  key to display Alarm and press the **SKL** key to confirm.
2. On/Off is displayed, press the **SKL** key to begin setting the alarm.
3. Press the  or  key to display Off, Once, Everyday or Weekday and press the **SKL** key to confirm.
4. Enter the time you want the alarm to sound using 2 digits for the hour and 2 digits for the minute and press the **SKL** key to confirm. Set ok is displayed briefly.

Note: Remember that your ME4851 uses the 24 hour clock.

5. Press the **SKR** key once to go back to the previous menu and set the ringer melody.
6. Press the ▼ key to display Ring Type and press the **SKL** key to confirm.
7. Press the ▲ or ▼ key to display and hear a sample of each of the ringer melodies. With the melody you want highlighted, press the **SKL** key to select. Set ok is displayed briefly.
8. Press the **SKR** key once to go back to the previous menu and set the ring volume.
9. Press the ▼ key to display Ring Volume and press the **SKL** key to confirm.
10. Press the ▲ key to increase or the ▼ key to decrease the volume and press the **SKL** key to select. Set ok is displayed briefly.
11. Press the  key to return to standby mode.

Silence the Alarm When it Sounds

When the alarm time is up, the alarm will sound for 30 seconds.

To silence the ring:

1. Press any key on the handset.

HANDSET SETTINGS MENU

The handset settings menu lets you personalise the settings on your handset.

When using the handset settings menu the  icon will be displayed.

Changing the Ringer Melody

You can select different ringer melodies to help you to distinguish between the different types of call you receive. You can set a different ringer melody for external calls, internal calls, each of your 6 phone book groups and for the Paging ring.

In the handset settings menu:

1. Press the ▲ or ▼ key to display Ring Type and press the **SKL** key to confirm.
2. Press the ▲ or ▼ key to display the Ring Type you want and press the **SKL** key to confirm.
3. Press the ▲ or ▼ key to scroll and hear the ringer melodies, with the one you want highlighted, press the **SKL** key to select. Set ok is displayed.
4. Press the ✂/⏻ key to return to standby mode.

Changing the Ringer Volume

For each of the different ring types you can set your preferred ringer volume level. There are 5 different volume levels.

In the handset settings menu:

1. Press the ▲ or ▼ key to display Ring Volume and press the **SKL** key to confirm.
2. Press the ▲ or ▼ key to display the ring type you want and press the **SKL** key to confirm.
3. Press the ▲ key to increase or the ▼ key to decrease the volume and press the **SKL** key to confirm. Set ok is displayed.
4. Press the ✂/⏻ key to return to standby mode.

Switching the Ringer On/Off

If you do not want to be disturbed by either external or internal calls you can switch the ringer off.

If the external ringer is set to on, the 📞 icon is displayed.

If the external ringer is set to off, the  icon is displayed.

In the handset settings menu:

1. Press the ▲ or ▼ key to display Ring On/Off and press the **SKL** key to confirm.
2. Press the ▲ or ▼ key to display either:
External On/Off for the external ringer
Or
Internal On/Off for the internal ringer
Press the **SKL** key to confirm.
3. Press the ▲ or ▼ key to display (for example) either Internal On or Internal Off and press the **SKL** key to confirm. Set ok is displayed.
4. Press the  key to return to standby mode.

Pre Fix Setting

When Pre Fix dialing is on, it will append the entered Pre fix number to the front of the dialing number.

Switching pre fix ringing On/Off

In the handset settings menu:

1. Press the ▲ or ▼ key to display Pre Fix and press the **SKL** key to select.
2. Pre Fix On/Off is displayed, press the **SKL** key to select.
3. Press the ▲ or ▼ key to highlight either Off or On and press the **SKL** key to select.

Storing a pre fix number

In the handset settings menu:

1. Press the ▲ or ▼ key to display Pre Fix and press the **SKL** key to select.

2. Press the ▼ key to display Pre Fix Edit and press the **SKL** key.
3. Enter a prefix number (max. 5 digits) and press the **SKL** key to confirm. Set ok is displayed.

To edit an existing prefix number:

Delete existing digits using the **SKR** key and enter a new prefix number and press **SKL** to confirm.

4. Press the  key to return to standby mode.

Call Barring

You can select from various call barring options:

Off - no calls are barred, all calls are allowed.

External Call - all external calls are barred, only internal calls are allowed.

Pre Call - calls beginning with a selected prefix will be barred.

All - all calls are barred, no calls are allowed.

Note: With call barring set, when you try to dial a barred number, the display will show Call is Barred. You will need to change the call barring setting to be able to dial out.

In the handset settings menu:

1. Press the ▲ or ▼ key to display Outgoing Call Bar and press the **SKL** key to select.
2. Enter the 4 digit PIN code (pre-set code 0000) and press the **SKL** key to confirm.
3. Press the ▲ or ▼ key to display the call barring option you want and press the **SKL** key to confirm.

If you selected Pre Call:

Enter the barred prefix number (up to 5 digits) and press the **SKL** key to confirm. Set ok is displayed.



If you do not enter a number for Pre Call barring, All calls will be barred as no number will match a 'blank'.

4. Press the /⏻ key to return to standby mode.

Message Waiting

If you have subscribed to a voice messaging service, the green message light on the base will flash to alert you if you have a message waiting.

To hear your messages, contact your voice messaging service provider.

Note: For quick dialling you can store the voice messaging service number on your phone.

To store/dial the voice messaging service number

In the handset settings menu:

1. Press the ▲ or ▼ key to display Message Waiting and press the **SKL** key to select.
2. Press the ▼ key to display Service and press the **SKL** key to confirm.
3. Enter the number of your messaging service provider and press the **SKL** key to confirm. Set ok is displayed.
4. Press the  key to dial the number.

Or

Press the /⏻ key to return to standby mode.

Note: in standby mode, user can press **P/✉** key to dial the service number.

To clear messages

When you have listened to your messages, to turn off the flashing message light:

In the handset settings menu:

1. Press the ▲ or ▼ key to display Message Waiting and press the **SKL** key to select.
2. Press the ▼ key to display Clear Message and press the **SKL** key to confirm.
3. Press the ✎/⏻ key to return to standby mode.

Changing the Display Wallpaper

Your ME4851 telephone has a choice of 4 wallpapers that will be shown on the handset display when in standby mode.

Note: If you select the wallpaper with the Motorola logo, the handset name will be displayed but it will not cover the logo.

In the handset settings menu:

1. Press the ▲ or ▼ key to display Wallpaper and press the **SKL** key to select.
2. Press the ▲ or ▼ key to select the wallpaper you want and press the **SKL** key to view the wallpaper.
3. Press the **SKL** key again to confirm.
4. Press the ✎/⏻ key to return to standby mode. The selected wallpaper is displayed.

Changing the Display Language

The text on the handset display can be shown in up to 11 different languages, including: English, German, French, Italian, Dutch, Spanish, Greek, Turkish, Hungarian, Portuguese, and Polish.

In the handset settings menu:

1. Press the ▲ or ▼ key to display Language and press the **SKL** key to select.
2. Press the ▲ or ▼ key to display the language you want and press the **SKL** key to confirm.
3. Press the ✂/⏻ key to return to standby mode. The display will show the selected language.

Changing the Display Contrast

There are 5 different contrast levels for the handset display.

In the handset settings menu:

1. Press the ▲ or ▼ key to display Contrast and press the **SKL** key to select.
2. Press the ▲ or ▼ key to select the contrast level you want and press the **SKL** key to confirm.
3. Press the ✂/⏻ key to return to standby mode.



Switching Key Tones On/Off



With key tones set to on, each time you press a key on the handset, you will hear a beep to confirm the button press.

In the handset settings menu:





1. Press the ▲ or ▼ key to display Key Tone and press the **SKL** key to select.
2. Press the ▲ or ▼ key to select either On or Off and press the **SKL** key to confirm. Set ok is displayed.
3. Press the ✂/⏻ key to return to standby mode.

Switching Auto Answer On/Off

The automatic call answering function (auto answer on) enables an incoming call to be taken immediately when the handset is lifted from the base station (or charger unit). It is not necessary to press the  or  key.

When auto answer is off, you will need to press the  key or the  key to take a call.



In the handset settings menu:

1. Press the  or  key to display Auto Answer and press the **SKL** key to select.
2. Press the  or  key to select either Auto Answer On or Auto Answer Off and press the **SKL** key to confirm. Set ok is displayed.
3. Press the  key to return to standby mode.

Giving the Handset a Name

You can assign a name to each handset that will be displayed when the handset is in standby mode.

In the handset settings menu:

1. Press the  or  key to display Handset Name and press the **SKL** key to select.
2. Enter a name for your handset and press the **SKL** key to confirm.
Set ok is displayed.
The handset name cannot include punctuation symbols.
See page 24 for help with entering names.
3. Press the  key to return to standby mode.

Selecting the LCD Mode

The display backlight comes on whenever a key is pressed or an incoming call is received.

You can determine how long the backlight stays on after the last button press:

In 'Power Save Mode' the backlight will remain on for 15 seconds.

In 'Extended Mode' the backlight will remain on for 30 seconds.

In the handset settings menu:

1. Press the ▲ or ▼ key to display LCD Mode and press the **SKL** key to select.
2. Press the ▲ or ▼ key to display the mode you want and press the **SKL** key to confirm. Set ok is displayed.
3. Press the  key to return to standby mode.

Resetting your Handset to the Default Settings

You can reset your handset so that all the pre-set (default) settings are restored.

In the handset settings menu:

1. Press the ▲ or ▼ key to display Default and press the **SKL** key to select.
2. Confirm? is displayed, press the **SKL** key to confirm. Set ok is displayed. Press the **SKR** key to cancel.
3. Press the  key to return to standby mode.

Handset Default Settings

External Ringer Melody	Canon	Prefix On/Off	OFF
Internal Ringer Melody	Espresso	Prefix Number	Empty
VIP Ringer Melody	High Tide	Number of Message Service	Empty
Business Ringer Melody	Higher Plane	Wallpaper	Wallpaper 1
Family Ringer Melody	Jubilation	Language	English
Friends Ringer Melody	Maple Leaf	LCD Contrast	Level 3
School Ringer Melody	Vivaldi	Key Tone	ON
Others Ringer Melody	Nightlife	Auto Answer	ON
Paging Ringer Melody	One Moment	Handset Owner Name	ME4851
Ringer Volume	Level 4	LCD Mode	Extended Mode
Receiver Volume	Level 3	Speed Dial	Empty
External Call Ring On/Off	ON		
Internal Call Ring On/Off	ON		

BASE SETTINGS MENU

The base settings menu lets you personalise the settings on your base station. When using the base settings menu the  icon will be displayed.

Changing the Ringer Melody

You can select from 5 different base ringer melodies.

In the base settings menu:

1. Press the ▲ or ▼ key to display Base Ring Tone and press the **SKL** key to select.
2. Press the ▲ or ▼ key to select the melody you want and press the **SKL** key to confirm. Set ok is displayed.
3. Press the  key to return to standby mode.

Switching the Base Ringer On/Off

In the base settings menu:

1. Press the ▲ or ▼ key to display Base Ring Tone and press the **SKL** key to select.
2. Press the ▲ or ▼ key to select either On or Off and press the **SKL** key to confirm. Set ok is displayed.
3. Press the  key to return to standby mode.

Priority Call Alert

With more than one handset registered to the base station, you can use priority call alert to select a particular handset to have priority over the other handsets. This handset will ring first when there is an incoming call. You can also determine whether you want the handset to ring 2, 4 or 6 times before all the other handsets start to ring.

If you want all handsets to ring and no handset to have priority, select All.

In the base settings menu:

1. Press the ▲ or ▼ key to display Priority call alert and press the **SKL** key to select.
2. Press the ▲ or ▼ key to select the handset you want to ring first and press the **SKL** key to confirm.
3. Press the ▲ or ▼ key to select the number of times the handset will ring before the other handsets start to ring (for example, for 4 times, select Ringtimes 4) and press the **SKL** key to confirm. Set ok is displayed.
4. Press the  key to return to standby mode.

Changing the Dial Mode

Your ME4851 telephone uses DTMF (Tone dialling) as the pre-set dialling mode. When using your telephone with some switch boards/PBX networks you may be required to change to Pulse dialling.

Note: Consult your switchboard provider if you are unsure which mode to use.

In the base settings menu:

1. Press the ▲ or ▼ key to display Dial Mode and press the **SKL** key to select.
2. Press the ▲ or ▼ key to select either DTMF or Pulse and press the **SKL** key to confirm. Set ok is displayed.
3. Press the  key to return to standby mode.

Registering Additional Handsets

Your ME4851 handset can be registered for use with up to 4 different base stations. A maximum of 6 handsets can be registered to use with your ME4851 base station.

Note: Any additional handsets must be GAP compatible. Even if a handset meets GAP standards, it is still possible some handset functions will not be available.

To register a new handset to your ME4851 base, you need to put the base into registration mode:

At the base:

1. Press and hold the Page key. The base will beep twice and the red light will flash for one minute.

On the handset, in the base settings menu:

1. Press the ▲ or ▼ key to display Register and press the **SKL** key to select.
2. Press the ▲ or ▼ key to select the number of the base you want to register the handset to and press the **SKL** key to confirm.

Note: The base stations that your handset is already registered to will be indicated by **.

3. Enter the handset PIN code and press the **SKL** key to confirm.
If the correct PIN is entered, the handset displays Searching while it attempts to connect with the base station. If registration is successful, OK is displayed.
4. Press the  key to return to standby mode.

Once the registration procedure is complete, the new handset will automatically be allocated the next available handset number. This number will be shown on the display.

De-register a Handset

You can use one handset to de-register another handset registered to the same base.

In the base settings menu:

1. Press the ▲ or ▼ key to display De-register and press the **SKL** key to confirm.
2. Enter the handset PIN code (pre-set code 0000) and press the **SKL** key to confirm.
3. Press the ▲ or ▼ key to highlight the number of the handset you want to de-register and press the **SKL** key to confirm. Confirm? is displayed.
4. Press the **SKL** key to select. OK is displayed.
5. Press the /⏻ key to return to standby mode.

Select a Base to Use

If your handset is registered to more than one base, you can select which base you want to use.

If you select Auto Base - your handset will automatically use the base with the best reception.

In the base settings menu:

1. Press the ▲ or ▼ key to display Select Base and press the **SKL** key to select.
2. Press the ▲ or ▼ key to select the number of the base you want to use or to select Auto Base and press the **SKL** key to confirm. OK is displayed.
Note: The base stations that your handset is registered to will be indicated by **.
3. Press the /⏻ key to return to standby mode.

Changing the PIN Code

For increased security you may want to change the PIN code to prevent any unauthorised changes being made to the settings on your telephone.

Always keep a note of the new PIN code.

In the base settings menu:

1. Press the ▲ or ▼ key to display System PIN and press the **SKL** key to select.
2. Enter the current PIN (pre-set code 0000) and press the **SKL** key to confirm.
3. Enter a new 4-digit PIN code and press the **SKL** key.
4. Re-enter the new PIN code and press the **SKL** key to confirm.
Set ok is displayed.
5. Press the **⏻/⏻** key to return to standby mode.

Note : This security function is only applicable for settings which requires a PIN code. (e.g. not applicable for ringer melody settings)

Changing the Flash Time (Recall)

You can change the recall (flash) time according to your Switchboard/PBX requirements. The recall times you can set are: 100, 250 and 600 msec. The pre-set recall time is 600 msec.

Note: Consult your switchboard/PBX provider for advice if unsure which setting you need.

In the base settings menu:

1. Press the ▲ or ▼ key to display Flash Time and press the **SKL** key to select.
2. Press the ▲ or ▼ key to select 100, 250 or 600 and press the **SKL** key to confirm.
Set ok is displayed.
3. Press the **⏻/⏻** key to return to standby mode.

Resetting your Base to the Default (Pre-Set) Settings

In the base settings menu:

1. Press the ▲ or ▼ key to display Default and press the **SKL** key to select.
2. Confirm? is displayed, press the **SKL** key to confirm. Set successfully is displayed.
Note: Press the **SKR** key to cancel.
3. Press the  key to return to standby mode.

Base Default Settings:

Base Ringer Melody	Ring Tone 1	Dial Mode	DTMF
Base Ring On/Off	ON	Flash Time	600ms
Priority Call Alert	All		
Clock Date/Clock time	01/01/2005	00:00	

Function Menu

The function menu allows you to use your handset as to play games on, or as walkie talkies (if you have 2 or more handsets).

When using the function menu the  icon will be displayed.

Games

There are 2 games you can choose from: Snake and Guess Number.

In the function menu:

1. Press the ▲ or ▼ key to display Games and press the **SKL** key to select.
2. Press the ▲ or ▼ key to display either Snake or Guess number and press the **SKL** key to select.

If you select **Snake**:

Four options will be displayed, use the ▲ or ▼ keys to highlight the option you want and press the **SKL** key to confirm.

Play - select to play the game.

Key controls:

Press **2** - to move UP

Press **6** - to move RIGHT

Press **8** - to move DOWN

Press **SKL** - to PAUSE

Press **4** - to move LEFT

Press **SKR** - to EXIT

Set speed - select to choose from 5 speeds at which to play the game. Press the ▲ key to go faster or the ▼ key to go slower.

Highest score - select to view the highest score.

Help - select to display the rules of the game and the control keys.

If you select **Guess Number**:

Four options will be displayed, use the ▲ or ▼ keys to highlight the option you want and press the **SKL** key to confirm.

Start Game - select to play the game.

Level - use to select the difficulty level - High, Medium or Low.

Highest score - select to view the highest score.

Help - select to display the rules of the game.

3. Press the **SKR** key to go back to the game menu options.

Or

Press the  key to return to standby

Walkie Talkie mode

With 2 or more handsets, you can use them as walkie talkies even when they are out-of-range from the base station.



In walkie talkie mode, you will not be able to use any other handset functions or make or receive calls. Please ensure that you Disable the walkie talkie mode to make or receive calls.

To use the handsets as walkie talkies

In the function menu:



1. Press the ▲ or ▼ key to display Walkie talkie and press the **SKL** key to select.
2. Press the ▲ or ▼ key to highlight Enable and press the **SKL** key to select.
3. Enter the Group ID code (e.g. 1234, any number with four digits) and press the **SKL** key to confirm.

Note: The Group ID of different handsets must be the same in order to communicate.

4. Enter the WT ID code (from 1 to 9) and press the **SKL** key to confirm.



Note: The WT ID code of handsets in the same group must be different, i.e. 9 handsets in the same group can communicate as walkie talkies provided that each handset has a different WT ID code, ranging from 1 through to 9.

You are now in Walkie Talkie mode.

5. To call another walkie talkie - press the **INT**, ,  keys then enter the other WT ID. Or

To call all other walkie talkies in the group - press the * key.

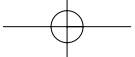
The called walkie talkie(s) will ring (internal ring) and the calling WT ID will be displayed to tell them who's calling.

- 
- To accept a call - press the  or **SKL** key.
You can now communicate using the handsets as walkie talkies.
Or
To reject a call - press the **SKR** key.
 - To exit walkie talkie mode, select Disable from the walkie talkie menu.

To exit walkie talkie mode and return the handset to normal mode

In the function menu:

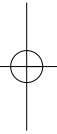
- Press the ▲ or ▼ key to display Walkie Talkie and press the **SKL** key to select.
 - Press the ▲ or ▼ key to highlight Disable and press the **SKL** key to select.
Exited will be displayed.
 - Press the  key to return to standby.
- 

Preparing your wireless headset for use

Charging the wireless headset batteries

Place the wireless headset in the charging cradle to charge. During charging, the charging indicator will illuminate. When the wireless headset is fully charged, the charging indicator will flash.

It is recommended that you charge your wireless headset for 4 hour before first use.

Note : Your wireless headset takes 4 hours to fully charge.

Note : If the wireless headset batteries become completely flat, you will need to charge the batteries for at least 2 hours before you can use your wireless headset again.

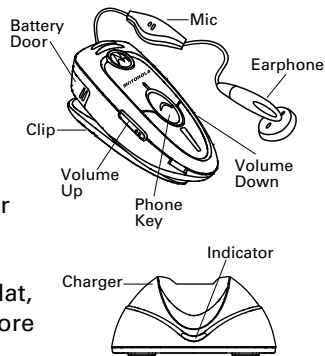

Registering the wireless headset to another base

The wireless headset has been already registered with the base unit with which it came. This section is only to provide information if you want to register the wireless headset to other base units.



Before trying to register your wireless headset, ensure that the base you are using is GAP compatible. Also, that the PIN of the base is set to either "0 000" or "1234" If your base is not GAP compatible, the headset may not work.

To enable your wireless headset to function, you will need to register it to the base you want to use it with.

Have your wireless headset close to the base station for the registering procedure.

1. Put your base in to registration mode - see your product user guide for instructions on how to do this.

Note: On most GAP compatible, DECT phones you will normally have to press and hold the PAGE key for several seconds. The PIN of most DECT or GAP phones is set as "0000" as the default.

2. ***Once the base is in registration mode:***

At the wireless Headset:

Press and hold the  Key for 5 seconds. The red and green lights flash alternately as your wireless headset searches for the base.

When the wireless headset successfully links with the base you will hear a confirmation tone, the red light will go off and the green light will begin to flash slowly.

Note: If registration fails, please refer back to the registration section of your telephone user guide, check the PIN of the base is set to "0000" or "1234" or contact your telephone Helpline.

Your wireless headset is now ready to use.

Basic Operation

Connecting your wireless headset

1. Position the earphone comfortably in your ear so that you will be able to hear your caller.

Answering a call

1. When you receive an incoming call, each time the phone rings, the green headset light will flash quickly, press the  key to answer the call.
2. Listen through the earphone and speak to your caller through the microphone.

Ending a call

1. Press the  Key to end the call.

Adjusting the wireless headset volume

During a call:

1. Press the **UP/DOWN** to increase/decrease the volume.

There are 5 volume levels. You will hear a double beep when you reach the highest or lowest volume.

Adjusting the ring volume

In standby mode (when the phone is idle):

1. Press the **UP/DOWN** to increase/decrease the volume.































There are 5 volume levels. You will hear an single tone when you reach the highest or lowest volume.

Wireless Headset lights and alert tones

LIGHTS AND TONES	DESCRIPTION
Red and green lights flash alternatively	Wireless Headset is in registration mode
Red LED ON continuously	Wireless Headset never registered to any base
Red light flashes slowly and you hear a warning alert of a single long beep every 20 seconds. (Standby time up to 72 hours and talk time up to 6 hours.)	Batteries are low and need charging
Red light flashes and a warning alert of two beeps every 5 seconds. (Range up to : -indoor approx 25m -outdoor approx 120m depending on environment)	Wireless Headset is out of communication range with the base, you will need to move closer to the base.

Green light flashes quickly, every 1 second	Wireless Headset is off-hook / in use
Green light flashes following ring cadence	Incoming call/Paging from the base
Green light flashes slowly, every 5 seconds	Wireless Headset is on-hook / in standby mode
No lights are on	Batteries are not installed / Batteries are too low

Quick Reference

Handset power on/off	Press and hold  / 
Making external calls	 or  , enter number/enter number  or 
Handsfree calls	(Make call) enter number,  / (during call) 
Receiving calls	 or  / (auto answer on) Lift handset from base/charger or  (for Wireless Headset)
Ending calls	 /  / Place handset in base/charger or  (for Wireless Headset)
Dial Phone book entry	SKL ,  /  to Phone Book, SKL ,  /  to Search, SKL ,  /  to entry, 
Access Call Waiting Line	 / COR / COR again to get to first line
Hold, Transfer call (PABX)	COR / Extension Number / COR
Making internal calls	INT ,  /  display handset number,  or 
Transfer call	INT , enter handset number,  /  to transfer
Teleconference	INT , enter handset number, when answers, 3
Page handsets	Page, handsets ring. Stop ring - Page or any key on handset
Mute on/off	During call, SKL to switch on/off
Key lock on/off	Press and hold #
Shortcut to Missed Calls log	From standby, 
Shortcut to Received Calls log	From standby, 

PHONEBOOK

Store entries	<p><i>In Phonebook menu: ▲/▼ to Add, SKL, enter name, SKL, enter number, SKL, SKL to Set Group, ▲/▼ to select group, SKL, ✎/⏻ to exit</i></p> <p><i>OR</i></p> <p><i>From standby: enter number SKL, ▲/▼ to select location, SKL, enter name, SKL, ▲/▼ to select group, SKL, ✎/⏻ to exit</i></p>
Search for entry	<p><i>In Phonebook menu: Search displayed, SKL, enter 1st letter, SKL, ▲/▼ to entry, SKL, to view details, ✎/⏻ to exit</i></p>
View Group Contacts	<p><i>In Phonebook menu: ▲/▼ to Groups, SKL, ▲/▼ to display Group, SKL, ▲/▼ to View, ▲/▼ to Entry, SKL, ✎/⏻ to exit</i></p>
Edit Group Contacts	<p><i>In Phonebook menu: ▲/▼ to Groups, SKL, ▲/▼ to display Group, SKL, ▲/▼ to Edit name, SKR to Delete, enter characters/digits, SKL to confirm, ✎/⏻ to exit</i></p>
Store Speed Dial	<p><i>In Phonebook menu: ▲/▼ to Speed Dial, SKL, ▲/▼ to Speed Dial Key, SKL, SKL to access Phone Book, ▲/▼ to display Entry, SKL to confirm, ✎/⏻ to exit</i></p>
Delete Speed Dial	<p><i>In Phonebook menu: ▲/▼ to Speed Dial, SKL, ▲/▼ to Speed Dial Key, SKL, ▼ to Delete, SKL, SKL to confirm, ✎/⏻ to exit</i></p>

CALLS LOG

View log	<i>In Calls log menu: ▲/▼ to scroll calls, SKL to view details of a call, SKR back to log, ✂/⏻ to exit</i>
View Dialed Calls log	<i>Using shortcut key from standby: ▲,▲/▼ to scroll calls, SKL to view details of a call, SKR back to log, ✂/⏻ to exit</i>
View Received Calls log	<i>Using shortcut key from standby: ▼,▲/▼ to scroll calls, SKL to view details of a call, SKR back to log, ✂/⏻ to exit</i>
View Missed Calls log	<i>Using shortcut key from standby: ⓄR,▲/▼ to scroll calls, SKL to view details of a call, SKR back to log, ✂/⏻ to exit</i>
Save to Phone book	<i>With call displayed: SKL, Save, SKL to confirm, ▲/▼ to select location, SKL, enter name, SKL, ✂/⏻ to exit</i>
Delete Calls log entry	<i>With call displayed: SKL, ▼ to Delete, ✂/⏻ to exit</i>
Delete entire Calls log	<i>In Callslog menu: ▲/▼ to Delete, SKL, ▲/▼ to highlight call log or Delete All, SKL to confirm, ✂/⏻ to exit</i>

TIMER MENU

Set Date and Time	<i>In Timer menu: ▲/▼ to Clock , SKL, enter date, SKL, enter time, SKL, ✂/⏻ to exit</i>
-------------------	--

Set Alarm	<i>In Timer menu: ▲/▼ to Alarm, SKL, On/Off displayed, SKL, ▲/▼ to select frequency, SKL, enter time, SKL, SKR, ▼ to Ring Type, SKL, ▲/▼ to select melody, SKL, SKR, ▼ to Ring Volume, SKL, ▲/▼ to select volume, SKL, Off to exit</i>
Silence Alarm	<i>Press any key</i>

HANDSET SETTING

Change ringer melody	<i>In Handset settings menu: ▲/▼ to Ring Type, SKL, ▲/▼ to select ring type, SKL, ▲/▼ to select melody, SKL, ✎/⏻ to exit</i>
Change ring volume	<i>In Handset settings menu: ▲/▼ to Ring Volume, SKL, ▲/▼ to select ring type, SKL, ▲/▼ to required volume, SKL, ✎/⏻ to exit</i>
Switch external ringer on/off	<i>In Handset settings menu: ▲/▼ to Ring On/Off, SKL, ▲/▼ to External On/Off, SKL, ▲/▼ to External On or External Off, SKL, ✎/⏻ to exit</i>
Switch internal ringer on/off	<i>In Handset settings menu: ▲/▼ to Rin Qn/off, SKL, ▲/▼ to Internal on/off, SKL, ▲/▼ to Internal on or Internal off, SKL, ✎/⏻ to exit</i>
Pre Fix on/off	<i>In Handset settings menu: ▲/▼ to Pre fix, SKL, SKL, ▲/▼ to display Off or on, SKL, ✎/⏻ to exit</i>

Store Pre Fix	<i>In Handset settings menu: ▲ / ▼ to Pre fix, SKL, ▼ to Pre fix edit, SKL, enter prefix number, SKL, ✂/⏻ to exit</i>
Call Barring	<i>In Handset settings menu: ▲ / ▼ to Outgoing call bar, SKL, enter 4 digit PIN, SKL, ▲ / ▼ to required option, SKL, (if Pre Call selected, enter number, then SKL) ✂/⏻ to exit</i>
Store Messaging Service Number	<i>In Handset settings menu: ▲ / ▼ to Message waiting, SKL, ▲ / ▼ to Service, enter service number, SKL, 📞 to dial number or ✂/⏻ to exit</i>
Clear Messages	<i>In Handset settings menu: ▲ / ▼ to Message waiting, SKL, ▲ / ▼ to Clear message, SKL, ✂/⏻ to exit</i>
Change display wallpaper	<i>In Handset settings menu: ▲ / ▼ to Wallpaper, SKL, ▲ / ▼ to select wallpaper, SKL, ✂/⏻ to exit</i>
Change display language	<i>In Handset settings menu: ▲ / ▼ to Language, SKL, ▲ / ▼ to select language, SKL, ✂/⏻ to exit</i>
Set display contrast	<i>In Handset settings menu: ▲ / ▼ to Contrast, SKL, ▲ / ▼ to set level, SKL, ✂/⏻ to exit</i>
Set Key tones on/off	<i>In Handset settings menu: ▲ / ▼ to Key tone, SKL, ▲ / ▼ to Key tone on or Key tone off, SKL, ✂/⏻ to exit</i>

Auto Answer on/off

*In Handset settings menu: ▲ / ▼ to Auto answer, **SKL**, ▲ / ▼ to Auto Answer On or Auto Answer Off **SKL**, ✎ / ⏻ to exit*

Handset name

*In Handset settings menu: ▲ / ▼ to Handset Name, enter a name **SKL**, ✎ / ⏻ to exit*

LCD Mode

*In Handset settings menu: ▲ / ▼ to LCD Mode, **SKL**, ▲ / ▼ to Extended Mode or Power Save Mode, **SKL**, ✎ / ⏻ to exit*

Reset handset

*In Handset settings menu: ▲ / ▼ to Default, Confirm? displayed, **SKL** to confirm, ✎ / ⏻ to exit*

BASE SETTINGS

Change ringer melody

*In Base settings menu: ▲ / ▼ to Base Ring Tone, **SKL**, ▲ / ▼ to select melody, **SKL**, ✎ / ⏻ to exit*

Base ringer On/Off

*In Base settings menu: ▲ / ▼ to Base Ring On/Off, **SKL**, ▲ / ▼ to display On or Off, **SKL**, ✎ / ⏻ to exit*

Priority call alert

*In Base settings menu: ▲ / ▼ to Priority Call Alert, **SKL**, ▲ / ▼ to select Priorit Handset, **SKL**, ▲ / ▼ to select no. of rings, **SKL**, ✎ / ⏻ to exit*

Change dial mode

*In Base settings menu: ▲ / ▼ to Dial Mode, **SKL**, set required mode, **SKL**, ✎ / ⏻ to exit*

Register a handset	<i>At base: Press and hold Page until 2 beeps sound. At handset, in base settings menu: ▲ / ▼ to Register SKL, ▲ / ▼ to select base number, SKL, enter PIN, SKL, when Register OK displayed ✕/⏻ to exit</i>
De-register a handset	<i>In Base settings menu: ▲ / ▼ to De-register, SKL, enter PIN, SKL, ▲ / ▼ to display handset number, SKL, Confirm? displayed, SKL to confirm ✕/⏻ to exit</i>
Select base to use	<i>In Base settings menu: ▲ / ▼ to Select base, SKL, to base number or Auto base, SKL, ✕/⏻ to exit</i>
Change PIN code	<i>In Base settings menu: ▲ / ▼ to System PIN, SKL, enter current PIN, SKL, enter new 4-digit PIN, SKL, re-enter new PIN, SKL, ✕/⏻ to exit</i>
Change Flash (Recall) Time	<i>In Base settings menu: ▲ / ▼ to Flash time, ▲ / ▼ to select time, SKL, ✕/⏻ to exit</i>
Reset Base	<i>In Base settings menu: ▲ / ▼ to Default, SKL, Confirm? displayed, SKL to confirm, ✕/⏻ to exit</i>

FUNCTION

Set WalkieTalkie mode

*In Function menu: ▲ / ▼ to WalkieTalkie, **SKL**▲ / ▼ to Enable,**SKL**, enter Group ID, **SKL**, enter WT ID, **SKL** -
In walkie talkie mode: Press **INT** then WTID code or **INT**, * to call*

Return to normal mode

*In Function menu: ▲ / ▼ to Walkie Talkie, **SKL**▲ / ▼ to Disable, **SKL**, ✖/⏻ to exit*

WARRANTY INFORMATION

MOTOROLA DOES NOT WARRANT ITS CORDLESS TELEPHONE PRODUCTS ("PRODUCT(S)") TO YOU, THE END-USER. A LIMITED WARRANTY FOR THIS PRODUCT IS PROVIDED TO YOU BY MOTOROLA'S DISTRIBUTOR ("DISTRIBUTOR") PURSUANT TO DOCUMENTATION INCLUDED WITH THIS PRODUCT. PLEASE CONTACT THE DISTRIBUTOR IF YOU EXPERIENCE PROBLEMS WITH THIS PRODUCT.

TO THE FULLEST EXTENT PERMITTED UNDER APPLICABLE LAW (A) MOTOROLA HEREBY DISCLAIMS ALL WARRANTIES OF ANY KIND RELATING TO THE PRODUCT THAT BIND THE MANUFACTURER, WHETHER EXPRESS, IMPLIED OR STATUTORY, INCLUDING BUT NOT LIMITED TO IMPLIED WARRANTIES OF MERCHANTABILITY, FITNESS FOR A PARTICULAR PURPOSE, OR ANY WARRANTY AGAINST INFRINGEMENT PROVIDED UNDER ANY LAW, AND (B) IN NO EVENT SHALL MOTOROLA BE LIABLE TO YOU OR ANY OTHER PARTY FOR ANY DIRECT, INDIRECT, GENERAL, SPECIAL, INCIDENTAL, CONSEQUENTIAL, EXEMPLARY OR OTHER DAMAGES ARISING OUT OF THE USE OR INABILITY TO USE THE PRODUCT (INCLUDING, WITHOUT LIMITATION, DAMAGES FOR LOSS OF BUSINESS PROFITS, BUSINESS INTERRUPTION, LOSS OF INFORMATION OR ANY OTHER PECUNIARY LOSS), OR FROM ANY BREACH OF WARRANTY, EVEN IF MOTOROLA HAS BEEN ADVISED OF THE POSSIBILITY OF SUCH DAMAGES. MOTOROLA SHALL NOT BE BOUND BY PRODUCT RELATED STATEMENTS NOT DIRECTLY MADE BY MOTOROLA NOR ANY WARRANTY OBLIGATIONS APPLICABLE TO THE DISTRIBUTOR.

WARRANTY INFORMATION

Alcom Electronics Pte Ltd. (Distributor) guarantees to you, the original purchaser, the digital cordless telephone and accessories which you have purchased from an authorised reseller (the "Products"), to be in conformance with the applicable specifications current at the time of manufacture for a term of 12 months from date of purchase of the Product(s) (Warranty Term). You must inform Distributor of the lack of conformity to the applicable specifications of any of the Products within a period of two (2) months from the date on which you detect a defect in material, workmanship or lack of conformity and in any event within a term not to exceed the Warranty Term, and must immediately submit the Product for service to Distributor's Repair or Service Centre.

During the Warranty term, Distributor will, at its discretion and without extra charge, as your exclusive remedy, repair or replace your Product which does not comply with this warranty; or failing this, to reimburse the price of the Product but reduced to take into account the use you have had of the Product since it was delivered. This warranty will expire at the end of the Warranty Term.

HOW TO GET WARRANTY SERVICE?

In order to be eligible to receive warranty service, you must present your receipt of purchase or a comparable substitute proof of purchase bearing the date of purchase. The digital cordless telephone should also clearly display the original compatible electronic serial number. Such information is contained with the Product.

For details, please contact:

Alcom Electronics Pte Ltd, 37 Kallang Pudding Road, #05-08, BLK-B Tong Lee Building,
SINGAPORE 349315, PH : 65 - 68412668 FAX : 65 - 68412628

You must ensure that all and any repairs or servicing is handled at all times by a Distributor's Service Centre in accordance with the Distributor's Service requirements. In some cases, you may be requested to provide additional information concerning the maintenance of the Products by Distributor's Service Centres only, therefore it is important to keep a record of any previous repairs, and make them available if questions arise concerning maintenance.

CONDITIONS

This warranty will not apply if the type or serial numbers on the Product has been altered, deleted, duplicated, removed, or made illegible. Distributor reserves the right to refuse free-of-charge warranty service if the requested documentation can not be presented or if the information is incomplete, illegible or incompatible with the factory records. Repair, at Distributor's option, may include reflashing of software, the replacement of parts or boards with functionally equivalent, reconditioned or new parts or boards. Replaced parts, accessories, batteries, or boards are warranted for the balance of the original warranty time period. The Warranty Term will not be extended. All original accessories, batteries, parts, and digital cordless telephone that have been replaced shall become the property of Distributor.

Distributor does not warrant the installation, maintenance or service of the products, accessories, batteries or parts.

Distributor will not be responsible in any way for problems or damage caused by any ancillary equipment not furnished by Distributor which is attached to or used in connection with the Products.

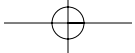

When the Product is used in conjunction with ancillary or peripheral equipment not supplied for this digital cordless telephone by Distributor, Distributor does not warrant the operation of the Product/peripheral combination and Distributor will not honour any warranty claim where the Product is used in such a combination and it is determined by Distributor that there is no fault with the Product.

WHAT IS NOT COVERED BY THE WARRANTY

This warranty is not valid if the defects are due to damage, misuse, tampering, neglect or lack of care and in case of alterations or repair carried out by unauthorised persons. The following are examples of defects or damage not covered by this product warranty

- Defects or damage resulting from use of the Product in other than its normal and customary manner.
- Defects or damage from misuse, access to incompatible sources, accident or neglect.
- Defects or damage from improper testing, operation, maintenance, installation, adjustment, unauthorised software applications or any alteration or modification of any kind.
- Breakage or damage to antennas unless caused directly by defects in material or workmanship.
- Products disassembled or repaired other than by Distributor in such a manner as to adversely affect performance or prevent adequate inspection and testing to verify any warranty claim.
- Defects or damage due to range, coverage, availability, grade of service, or operation of the cellular system by the cellular operator.
- Defects or damage due to moist, liquid or spills of food.

- All plastic surfaces and all other externally exposed parts that are scratched or damaged due to customer normal use.
- Products rented on a temporary basis.
- Periodic maintenance and repair or replacement of parts due to normal wear and tear.

Note: The talk-time, stand-by time and total life cycle of the rechargeable batteries for your digital cordless telephone will depend on usage conditions and network configurations. As a consumable product, the specifications indicate that you should be able to obtain optimum performance for your digital cordless telephone within the first two months from date of purchase.

The warranty for the rechargeable batteries becomes void if (i) the batteries are charged other than by original battery chargers specified for the charging of the battery, (ii) any of the seals on the battery are broken or show evidence of tampering, (iii) the battery is used in equipment or service other than the digital cordless telephone for which it is specified.

Depending on operating conditions and your usage habits, wear and tear might take place of components including mechanical problems related to Product housing, paint, assembly, sub-assemblies, displays and keyboards and any accessories which are not part of the Product's in-box configuration. The rectification of faults generated through wear and tear and the use of consumable items like batteries is considered to be your responsibility and therefore Distributor will not provide the free Warranty repair service for these items.

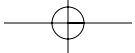

Please make and retain a note of all data you have inserted into your Product for example names and phone numbers, before submitting your Product for a Warranty service as such data may be deleted or erased as part of the repair or service process.

OUT OF WARRANTY REPAIRS

If you request Distributor to repair your Product any time after the Warranty term or where this warranty does not apply due to the nature of the defect or fault, then Distributor may in its discretion carry out such repairs subject to you paying Distributor its fees for such a repair or it may refer you to an authorised third party to carry out such repairs.

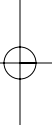

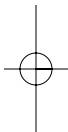
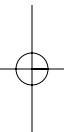
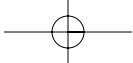

MOTOROLA and the Stylized M Logo are registered in the US Patent & Trademark Office.
All other product or service names are the property of their respective owners. © Motorola, Inc. 2004.

