



MOTOROLA



TLKR T6 Owner's Manual



CONTENTS

Product Safety and RF Exposure for Portable Two-Way Radios	2	Channel Scan Feature	10
Features	2	Monitor Mode Feature	11
Control and Functions	3	Voice Operated Transmission	11
Display	4	Transmitting a Call Tone	12
Package Contents	5	Key Tone	12
Install the Battery	5	Roger Beep	12
Battery Level and Low Battery Alert	5	Automatic Power Save Feature	13
Charging the Radio	5	Auto Power Off	13
Charging the Battery	6	Room Monitor Feature	13
Using the Radio	6	Specifications	14
Turning the Radio on and Adjusting the Volume	6	Frequency Chart	14
Adjusting the Sound (Key tone)	7	CTCSS Chart (Hz)	15
Talking on Your Radio	7	DCS Code	16
LCD Backlight	7	Warranty Information	17
Navigating through the Menu	7	What is Not Covered by the Warranty	17
Select Menu	8	Copyright Information	18
Choosing a Channel	8		
Choosing a Sub-code	8		
Dual Watch Mode	9		
Stopwatch Activation	9		
Key lock Activation	9		
Mode Menu	10		

Product Safety and RF Exposure for Portable Two-Way Radios



Caution

Before using this product, read the operating instructions for safe usage contained in the Product Safety and RF Exposure booklet enclosed with your radio.

ATTENTION!

Before using this product, read the RF energy awareness information and operating instructions in the Product Safety and RF Exposure booklet to ensure compliance with RF energy exposure limits.

Features

- 8 PMR Channels
 - 121 Sub-Codes (38 CTCSS Codes & 83 DCS codes)
 - Up to 8 km Range*
 - Internal VOX Circuitry
 - 5 Selectable Call Tone Alerts
 - Backlit LCD Display
 - Headset Jack for Optional Headset
 - Roger Beep
 - Up timer
 - Room Monitor
 - Battery Charger
 - Battery level Meter
 - Channel Monitor
 - Channel Scan
 - Dual Watch
 - Keypad Lock
 - Auto Power Off function
- * Range may vary depending on environmental and/or topographical conditions

Controls and Functions

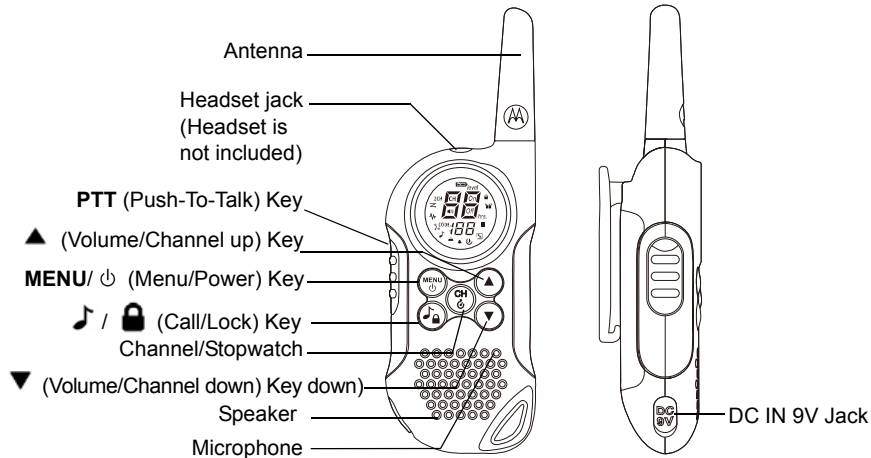

Display

1. Battery Level Meter
2. Dual Watch Indicator
3. Scan Indicator
4. Monitor Indicator
5. VOX Indicator
6. Sending call tone/Call tone
7. Key Tone Indicator
8. Roger beep tone Indicator
9. APO (Auto power off) Indicator
10. Room monitor Indicator
11. Transmit/Receive Indicator
12. Keypad Lock Indicator

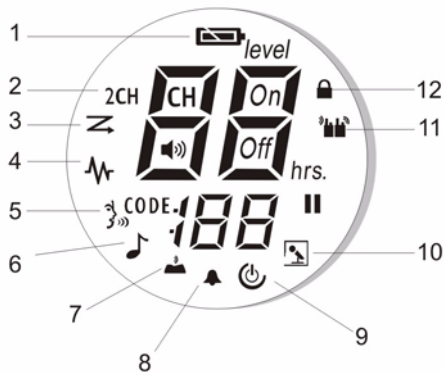

Congratulations on your purchase of the TLKR T6 radio. This product is a lightweight, palm-sized radio. Use it at sporting events to stay in contact with family and friends, hiking, skiing, outdoors for vital communication. This compact, state-of-the-art device is equipped with many features.

Package Contents

Your package contains two TLKR T6 radios, two belt clips, one charging cradle, AC adapter, two battery support brackets, two rechargeable NiMH battery packs, and this reference guide. You may operate the unit 4 AAA alkaline batteries (not included).

Install the Battery

Your TLKR T6 radio uses the NiMH battery pack or 4 AAA alkaline batteries (not included). If alkaline batteries are used, we recommend using high quality alkaline batteries.

To install the NiMH battery pack:

1) Make sure your radio is OFF.

2) Remove the battery compartment door by pressing the tab at the bottom of the compartment door, allowing the door to be removed.

3) Install the NiMH battery pack into the battery compartment. Be certain to follow the + and – symbols in the compartment. Installing the battery pack incorrectly will prevent the unit from operating.

4) Replace the battery compartment door.

Battery Level and Low Battery Alert

This unit has a battery level meter on the display to indicate the status of the batteries. When the battery in the unit is low, the battery level meter icon  will flash. Recharge the NiMH rechargeable batteries immediately.

Charging the Radio

If you use the rechargeable NiMH battery pack, two TLKR T6 radios can be charged directly or by using the supplied charging cradle.

Make sure to turn the radio OFF before placing the radio in the charging cradle. Otherwise the battery level meter icon won't indicate properly.

Direct Charge:

1. Connect the DC adapter's plug to the radio's DC IN 9V jack and plug the other end to a vehicle's accessory power outlet.

Using the Charging Cradle:

1. Connect the AC adapter to DC IN 9V and to a standard electrical outlet.
2. Set the charging cradle on the desk or tabletop, and place the radio in the charging cradle with the keypad facing forward.
3. Make sure that the LED illuminates. Charge the battery pack for 16 hours and remove the radio from the charging cradle after charge.

Note:The charge indicator LEDs will remain on as long as the radios are left in the charger.

Charging the battery

You can charge the NiMH battery pack itself using the included battery support bracket.

1. Place the battery support bracket into the charging cradle.
2. Install the NiMH battery pack applying its charging contacts to those of charging cradle. Installing the batteries incorrectly will

prevent the unit from charging.



3. Make sure that the LED illuminates. Charge the battery pack for 16 hours .

Note:The charge indicator LEDs will remain on as long as the radios are left in the charger.





Using the Radio

In order to get the most out of your new radio, read this reference guide completely before attempting to operate the unit.

Turning the Radio On and Adjusting the Volume



1. Press and hold the **MENU/**  key to turn the radio ON, and increase the volume by pressing the **▲** key. To decrease the volume, press the **▼** key.
2. Press and hold the **MENU/**  key again to turn the radio OFF.

Adjusting the Sound (Key tone)

Your radio emits a beep each time one of the keys (except for the **PTT** and  key) is pressed. To turn this sound OFF or ON, press **MENU**/ button 5 times, the Key tone icon is flashing. Press the  key to switch ON. Press the  key to switch OFF.

Talking on Your Radio

To talk to others using the radio:

1. Press and hold the **PTT** key and speak in a clear, normal voice about 5-8 cms away from the microphone. While you are transmitting, the  icon will appear on the display. To avoid cutting off the first part of your transmission, pause slightly after pressing the **PTT** button before you start talking.
2. When you have finished speaking, release the **PTT** key. You can now receive incoming calls. While receiving, the  icon will appear on the display.



Note:When you continue to transmit for 60 seconds, the radio emits a TX Time Out tone and the  icon flashes. The radio will stop transmitting.

LCD Backlight

The LCD backlight will automatically turn ON when any key (except for PTT) is pressed. The LCD display will illuminate for 10 seconds after the last key pressed.

Navigating through the Menu

To access the advanced features of the TLKR T6 your radio has two Menu functions.

1. To enter the Menu, press the **MENU**/ key.
2. Additional presses of the **MENU**/ key will advance you through the Menu until exiting to "Normal" operating mode.

Select Menu

Your radio navigates through Select Menu as follows:

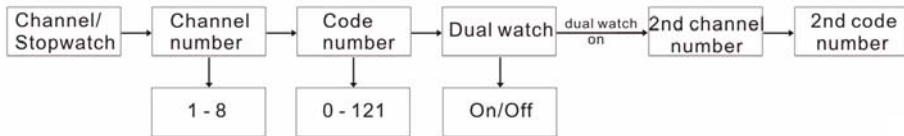

Choosing a Channel

Your radio has 8 channels and 121 Sub-codes you can use to talk to others. In order to speak to someone, each of you must set to the same channel and Sub-code.

To choose a channel:

1. Enter the Select Menu. Channel Indicator will blink.
2. Press the ▲ or ▼ key to increase or decrease the channel number displayed. If you press and hold the ▲ or ▼ key, the channel number increase or decrease continuously.
3. Go to Sub-code setting to choose a Sub-code.

Choosing a Sub-code



Allocating a Sub-code to your radio will help to reduce interference but remember that the radios that have different Sub-codes set will not be able to communicate with each other. Each of the channels 1-8 may have any one of the codes from 0 to 121.

1. Enter the Select Menu. Advance through the Select Menu until the Sub-code indicator blinks.
2. Press the ▲ or ▼ key to increase or decrease the channel number displayed. If you press and hold the ▲ or ▼ key, the channel number increase or decrease continuously.
3. Exit the Select Menu.

Dual Watch Mode

Your radio can scan the current channel and another channel alternately. You need to set a channel number and its Sub-code for another channel.

To set another channel and start Dual Watch:

1. Navigate through the Select Menu until the 2CH CH icon blinks.
2. Press the ▲ or ▼ to select the channel number, then press the  key.
3. Press the ▲ or ▼ to select the Sub-code, then press the  key.

Note: If you set the same channel number and Sub-code as the current channel, Dual Watch doesn't work.

To turn the Dual Watch mode OFF:



Press the  key then set to OFF mode.

Stopwatch Activation

You can use this radio as Stopwatch timer. It can time up to 60 minutes and 59 seconds.



Note: You can receive incoming signals during this mode.

To use the Stopwatch Timer

1. Press and hold the  key until Stopwatch timer will display.
2. Press ▲ to start Stopwatch timer. Pressing the ▲ key again will pause the timer.
3. Press the ▼ key to reset the Stopwatch timer.
4. Press and hold the  key to exit the Stopwatch timer function

Key Lock Activation

To Lock the keypad:

Press and hold the  key. The  icon appears.

To Unlock the keypad:

Press and hold the  key again. The  icon disappears.

Mode Menu

Your radio navigates through Select Menu as follows:

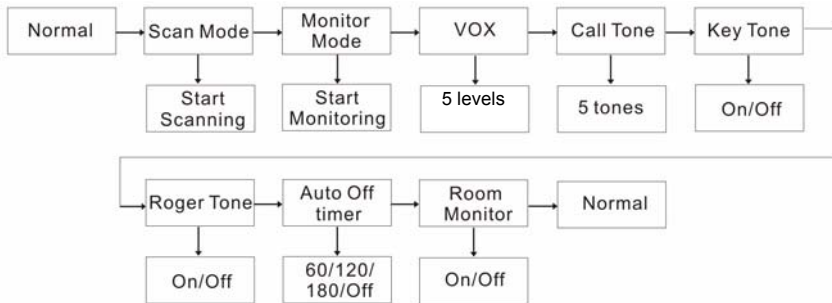

Channel Scan Feature

Your TLKR T6 radio has a channel scan feature that allows you to easily scan all 8 channels. When an active channel is detected, the radio will pause on that channel until the channel is clear. Then after a 2 second pause, the radio will continue scanning. Pressing the **PTT** key while the scan is paused on a channel will allow you to transmit on that channel and exit scan mode.

To turn the channel scan ON:

1. Enter the Mode Menu. Advance through the menu until  icon blinks. Press the **▲** key to turn the Scan function On. Scanning channel will start and the Scan icon is displayed.



To turn the Scan OFF:

1. Press the **MENU/⏻** the scan icon blinks, press **▼** key to turn Off the Scan function.



Monitor Mode Feature

Your TLKR T6 allows you to listen for weak signals on the current channel at the press of a key.

To turn the Monitor mode ON:

1. Enter the Mode Menu. Advance through the menu until the  icon blinks. Press the  key to turn the Monitor function On. Monitoring channel will start and the Monitor icon is displayed.





To turn the Monitor OFF:

2. Press the **MENU**/ and advance through the Monitor mode. Press the  key to turn Off the Monitor function.

Voice Operated Transmission



Your TLKR T6 radio is equipped with a user selectable Voice Operated Transmitter (VOX) that can be used for automatic voice transmissions. The VOX feature is designed for hands-free purposes. Transmission is initiated by speaking into the microphone of the radio or headset (headset is not included) instead of pushing the PTT key.

To select the VOX level:



1. Enter the Mode Menu. Advance through the Menu until the  icon blinks. The current level (OFF, 1-5) also blinks. Level Off disables VOX, while levels 1-5 set the sensitivity of the VOX circuit.
2. Press the  or  key to select the desired VOX sensitivity level. Use Level 1 in quiet environments, and use level 5 in very noisy environments. You can find the appropriate sensitivity level by speaking into the microphone. If the  icon flashes, your voice is accepted.
3. Exit the Select Menu.

Note:When you continue to transmit using the VOX function for 60 seconds, the radio emits a TX Time Out tone and the  icon flashes for 5 seconds.

Transmitting a Call Tone

Your TLKR T6 radio is equipped with 5 selectable call tones that will be transmitted when the /  key is pressed.

To select a call tone:



1. Enter the Mode Menu. Advance through the menu until the  icon blinks. The current call tone number (1-5) also blinks.
2. Press the  or  key to increase or decrease the number to the desired call tone. Each tone will be heard through the speaker.
3. Exit the Select Menu.

To transmit the selected call tone, press the  key. The selected tone will automatically be transmitted for a fixed length of time. Call tone will be cancelled when the **PTT** key is pressed.

Key Tone

Your radio emits a tone each time one of the keys (except for the PTT key) is pressed.



To turn the Key tone ON or OFF:

1. Enter the Mode Menu. Advance through the menu until the  icon blinks.
2. Press the  key to turn On or  key to turn Off the key tone.
3. Exit the Select Menu.

Roger Beep

Roger Beep is a BEEP that is sent to notify the end of transmission (PTT and VOX transmission). Roger Beep can be heard through the speaker when Key Beep is on. It is transmitted even if Key Beep is turned off. However, Roger Beep will not be heard from the speaker.

To turn Roger Beep OFF or ON:



1. Enter the Mode Menu. Advance through the menu until the  icon blinks.
2. Press the  key to turn On or  key to turn Off the Roger Beep tone.
3. Exit the Select Menu.

Automatic Power Save Feature

Your radio has a unique circuit designed to dramatically extend the life of the batteries. If there is no transmission nor an incoming call within 3 seconds, your radio switches to the Power Save mode. The radio is still able to receive transmissions in this mode.

Auto Power Off

Auto Power Off feature allows you to set the time that the radio turns off automatically.



1. Enter the Mode Menu. Advance through the menu until the  icon blinks.
2. Press the  or  key to select the time from Off, 60, 120 and 180 minutes.
3. Exit the Select Menu.

Room Monitor Feature

You can use one of your TLKR T6 radios as a room monitor and use the other radio to listen to and keep a check on the voice in another room. When you set the room monitor feature, the monitoring radio will detect voice/noises (according to the sensitivity level you set) and transmit back to the listening radio without pushing the **PTT** key. The monitoring radio is

not able to receive any transmissions in this mode.

To turn the Room Monitor ON or OFF:

1. Enter the Mode Menu. Advance through the menu until the  icon blinks.
2. Press the  key to turn On or  key to turn Off the key tone.
3. Exit the Select Menu.

Note:

- Pressing the PTT key in Room Monitor mode is invalid and the radio emits PTT Error Tone.
- When the voice/noise in another room continues more than 60 seconds, the monitoring radio stops monitoring for 5 second, and resumes.

Specifications

Channels	8 PMR
Sub-Codes	121 (38 CTCSS and 83 DCS Codes)
Operating Frequency	446.00625 - 446.09375 MHz
Power Source	AAA Ni-MH battery Pack 4 AAA Alkaline Batteries (not included)
Range	Up to 8 km
Battery Life	16 Hours typical Alkaline Bateries 14 Hours typical NiMH Battery pack

Frequency Chart (MHz)

Ch.	Freq.
1	446.00625
2	446.01875
3	446.03125
4	446.04375
5	446.05625
6	446.06875
7	446.08125
8	446.09375

Approved Accessories List

Please contact your dealer or retailer to purchase these accessories.

Motorola Part No.	Description
----------------------	-------------

CTCSS Chart (Hz)

Code No.	Tone Frequency (HZ)	Code No.	Tone Frequency (HZ)	Code No.	Tone Frequency (HZ)
0	Off	13	103.5	26	162.2
1	67.0	14	107.2	27	167.9
2	71.9	15	110.9	28	173.8
3	74.4	16	114.8	29	179.9
4	77.0	17	118.8	30	186.2
5	79.7	18	123.0	31	192.8
6	82.5	19	127.3	32	203.5
7	85.4	20	131.8	33	210.7
8	88.5	21	136.5	34	218.1
9	91.5	22	141.3	35	225.7
10	94.8	23	146.2	36	233.6
11	97.4	24	151.4	37	241.8
12	100.0	25	156.7	38	250.3

DCS Code

Code No.	Code	Code No.	Code	Code No.	Code	Code No.	Code	Code No.	Code	Code No.	Code
39	023	53	114	67	174	81	315	95	445	109	631
40	025	54	115	68	205	82	331	96	464	110	632
41	026	55	116	69	223	83	343	97	465	111	654
42	031	56	125	70	226	84	346	98	466	112	662
43	032	57	131	71	243	85	351	99	503	113	664
44	043	58	132	72	244	86	364	100	506	114	703
45	047	59	134	73	245	87	365	101	516	115	712
46	051	60	143	74	251	88	371	102	532	116	723
47	054	61	152	75	261	89	411	103	546	117	731
48	065	62	155	76	263	90	412	104	565	118	732
49	071	63	156	77	265	91	413	105	606	119	734
50	072	64	162	78	271	92	423	106	612	120	743
51	073	65	165	79	306	93	431	107	624	121	754
52	074	66	172	80	311	94	432	108	627		

Warranty Information

The authorized Motorola dealer or retailer where you purchased your Motorola two-way radio and/or original accessories will honour a warranty claim and/or provide warranty service.

Please return your radio to your dealer or retailer to claim your warranty service. Do not return your radio to Motorola.

In order to be eligible to receive warranty service, you must present your receipt of purchase or a comparable substitute proof of purchase bearing the date of purchase. The two-way radio should also clearly display the serial number. The warranty will not apply if the type or serial numbers on the product have been altered, deleted, removed, or made illegible.

What Is Not Covered By The Warranty

Defects or damage resulting from use of the product in other than its normal and customary manner or by not following the instructions in this user manual.

Defects or damage from misuse, accident or neglect.

Defects or damage from improper testing, operation, maintenance, adjustment, or any alteration or modification of any kind.

Breakage or damage to aerials unless caused directly by defects in material or workmanship.

Products disassembled or repaired in such a manner as to adversely affect performance or prevent adequate inspection and testing to verify any warranty claim.

Defects or damage due to range.

Defects or damage due to moisture, liquid or spills.

All plastic surfaces and all other externally exposed parts that are scratched or damaged due to normal use.

Products rented on a temporary basis.

Periodic maintenance and repair or replacement of parts due to normal usage, wear and tear.

Copyright Information

The Motorola products described in this manual may include copyrighted Motorola programs, stored semiconductor memories or other media. Laws in the United States and other countries preserve for Motorola, certain exclusive rights for copyrighted computer programs, including the exclusive right to copy or reproduce in any form, the copyrighted Motorola programs.

Accordingly, any copyrighted Motorola computer programs contained in the Motorola products described in this manual may not be copied or reproduced in any manner without express written permission of Motorola. Furthermore, the purchase of Motorola products shall not be deemed to grant either directly or by implication, estoppel, or otherwise, any license under the copyrights, patents or patent applications of Motorola, except for the normal non-exclusive royalty free license to use that arises by operation of law in the sale of a product.

MOTOROLA, the Stylized M Logo and all other trademarks indicated as such herein are trademarks of Motorola, Inc. ® Reg. U.S. Pat. & Tm. Off.

© Motorola, Inc. 2010