

USER GUIDE

UK

DECT PHONE ECLIPSE 10/15



P1

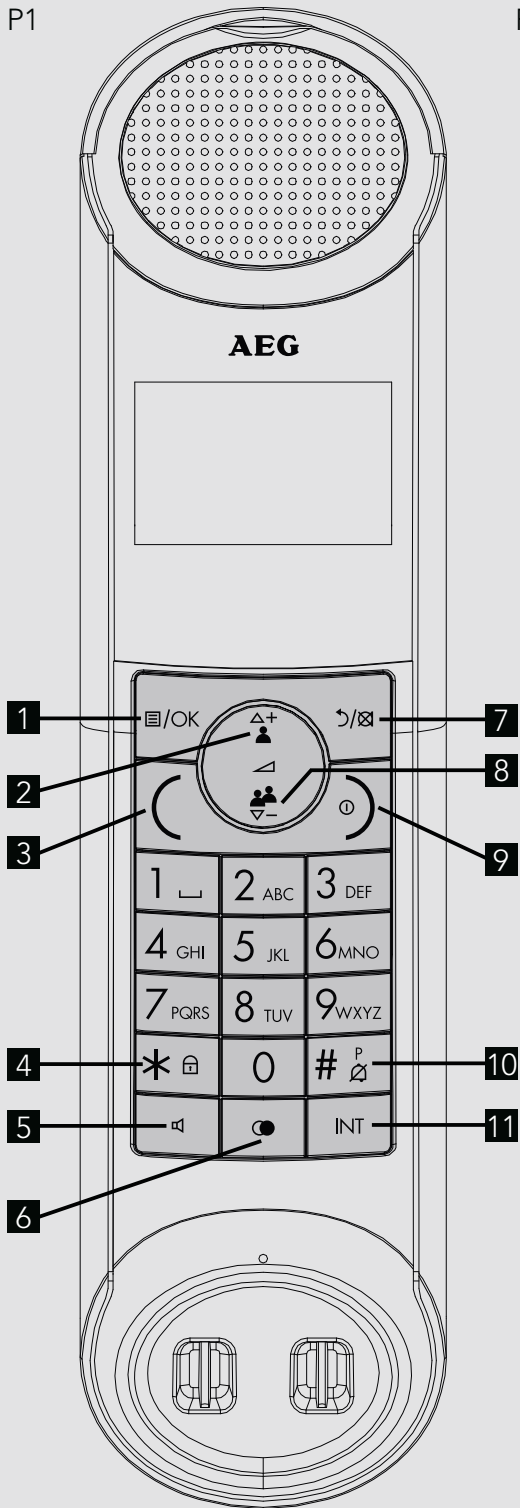

P3

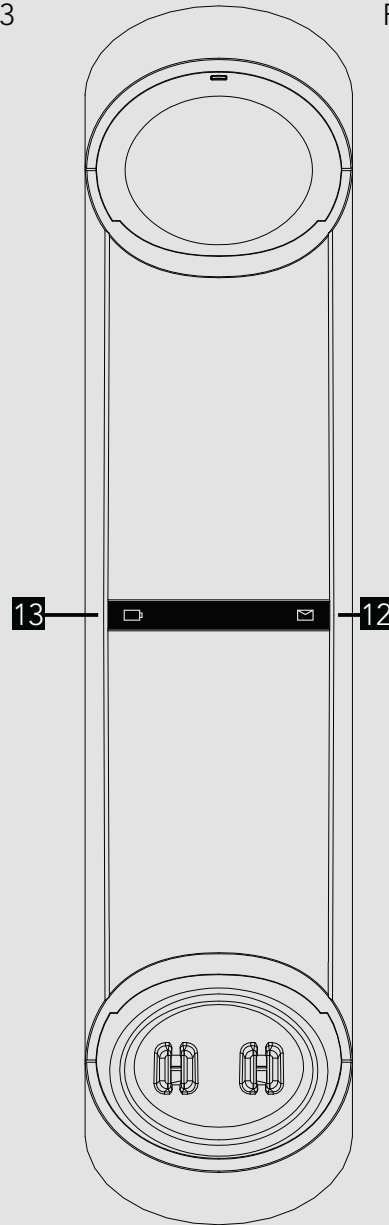

P4

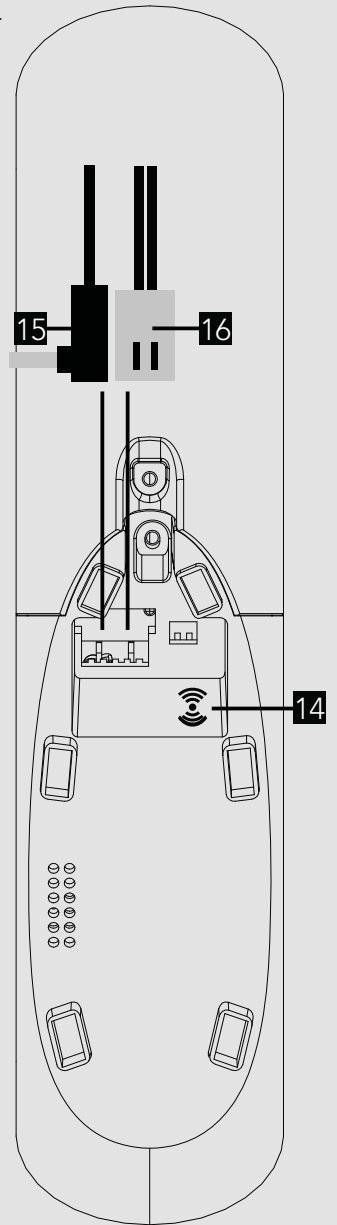

P2



P5

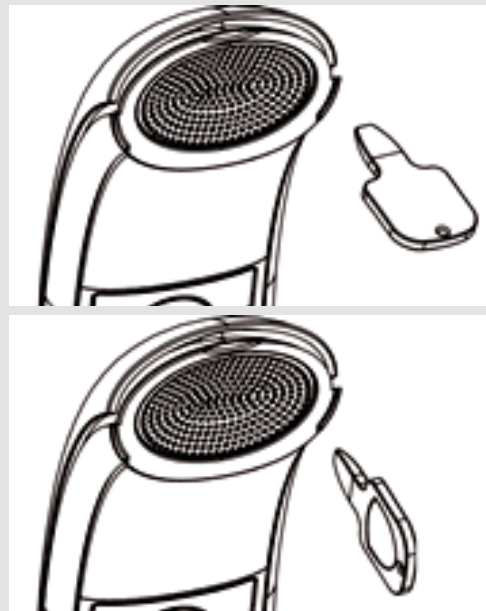

1. BECAUSE WE CARE

Thank you for purchasing this product. This product has been designed and assembled with utmost care for you and the environment. This is why we supply this product with a quick installation guide to reduce the number of paper (pages) and therefor save trees to be cut for making this paper. A full and detailed user guide with all the features described can be found on our website www.aegtelephones.eu. Please download the full user guide in case you want to make use of all the advanced features of your product. To save the environment we ask you not to print this full user guide. Thank you for supporting us to protect our environment.

2. IMPORTANT SAFETY INSTRUCTIONS

Please follow these safety instructions when using your telephone equipment to reduce risk of fire, electric shock and injury:

- Read and understand all the instructions.
- Follow all warnings and instructions marked on the product.
- Unplug this product from the wall outlet before cleaning. Do not use liquid cleaners or aerosol cleaners. Use a damp cloth for cleaning.
- Keep this product away from hot, humid conditions or strong sunlight, and don't let it get wet or use it near water (for example, near a bath tub, kitchen sink, and swimming pool).
- Do not overload wall outlets and extension cords as this can result in the risk of fire or electric shock.
- Unplug this product from the wall outlet under the following conditions:
 - >When the power supply cord or plug is damaged.
 - >If the product fails to operate normally despite following the operating instructions.
 - >If the product has been dropped and the cabinet has been damaged.
 - >If the product exhibits a distinct change in performance.
- NEVER use your phone outdoors during a thunderstorm. Unplug the base from the telephone line and the mains socket when there are storms in your area. Damage caused by lightning is not covered by the guarantee.
- Do not use the telephone to report a gas leak in the vicinity of the leak.
- Use only the supplied NiMH (Nickel Metal Hydride) batteries that came with your phone or an authorized replacement recommended by the manufacturer. There is a risk of explosion if you replace the battery with an incorrect battery type. The use of other battery types or non-rechargeable batteries/primary cells can be dangerous. They may cause interference and/or damage to the unit or surroundings. The manufacturer will not be held liable for damage arising from such non-compliance.
- Do not use third party charging pods. Damage may be caused to the batteries.
- Please ensure that the batteries are inserted in the correct polarity.
- Dispose of batteries safely. Do not burn, immerse them in water, disassemble, or puncture the batteries.

3. INTENDED USE

This telephone is intended to be connected to a public analogue telephone network or to an analogue extension of a compatible PBX system.

4. PACKAGE CONTENT

The package contains the following items:

- 1 Eclipse Handset
- 1 Base Station
- 1 Mains Power Adapter
- 1 Telephone Line Cord
- 2 AAA NiMH Rechargeable Batteries
- 1 Back Cover for the Eclipse Handset
- 1 Back Cover Unlock Tool
- 1 User Guide

5. HANDSET & BASE CONNECTION

- When purchased, all handsets are already registered to the base unit and should link to it when they are all powered up.
- To use your cordless handset and base unit together, you must be able to establish a radio link between them. The signal between the handset and the base unit is in accordance with the normal standards for a DECT phone: Maximum range up to 300 metres outdoors or 50 metres indoors. Be aware that:
 - > Large metal objects, such as refrigerators, mirrors or filing cabinets, between the handset and the base unit may block the radio signal.
 - > Solid structures, such as walls, may reduce the signal strength.
 - > Electrical equipment may cause interference and/or affect the range.
- Do not place the base unit close to another telephone, TV or audio equipment - it may cause interference.
- Putting the base unit as high as possible ensures the best signal.
- If the sound in the earpiece becomes faint or distorted during a call, you may be going out of range of the base unit. Move nearer to the base unit within 20 seconds; otherwise the line may be cut off.

6. INSTALLING YOUR PHONE

6.1 Connecting the Base Station (See P4)

- Plug the mains power cable **(15)** and telephone line cord **(16)** into the base station.
- Plug the power adapter into a 100 - 240Vac, 50 - 60Hz mains power socket and the telephone line cord into a telephone line socket.

Warning: Always use the cables provided in the box. Use only the supplied adaptor. Using other power adapter may damage the unit.

Note: Place the base unit within easy reach of the mains power socket. Never try to lengthen the mains power cable. The base station needs mains power for normal operation and the cordless handsets will not work without it.

6.2 Installing and Charging the Rechargeable Batteries

- Insert the 2 supplied batteries into the battery compartment, observing the correct polarity (see markings inside battery compartment).

Warning: Use only the supplied NiMH rechargeable batteries.

- Place the back cover over the back of the handset and press down until it clicks into place.
- Place the handset on the base and charge for 15 hours before using the handset for the first time.
 - >The handset will give a double beep when it is properly placed on the base and the battery charging indicator on the base lights up to indicate charging.

Note: The handset may become warm when the batteries are being charged or during prolonged periods of use. This is normal and does not indicate a fault.

CAUTION











Risk of explosion if the battery is replaced by an incorrect type. Dispose of used batteries according to the instructions.

6.3 Removing the back cover of the Eclipse Handset (See P5)











Insert the supplied key into the groove as indicated in the illustration and twist it clockwise to release the back cover.

7. GETTING TO KNOW YOUR PHONE

7.1 Overview of the Handset and Base Station



#	Icon	Meaning
1		In standby mode, press to enter the Main Menu list. Press to select an item, or to save an entry or setting.
2		In menu mode, press to scroll up. During a call or message playback, press to increase the volume. In standby mode, press to access the call log (CID).
3		In standby mode, press to make or answer a call. During a call, press to send a Flash signal for network services.
4		In standby mode, press to make or answer a call in speakerphone mode. During a call, press to switch between speakerphone and earpiece.
5		Press and hold to switch the key lock on or off
6		In standby mode, press to access the redial list.
7		Press to cancel an action. During pre-dialling, press to delete the last digit entered. During a call, press to mute the microphone and press again to resume conversation.
8		In menu mode, press to scroll down. During a call, or message playback, press to decrease the volume. In standby mode, press to access the phonebook list.
9		During a call, press to hang up. During programming, press to cancel and exit without making changes. In standby mode, press and hold to power the handset on/off.
10		Press and hold to turn the handset ringer off. Press and hold to add a dialling pause when dialling or entering numbers into the phonebook.
11	INT	In standby mode or during a call, press to initiate an intercom call or transfer a call.

7.2 Display Icons and Symbols on the handset (See P2)







Icon	Meaning
	Displays when the battery is fully charged. Internal segments cycle while charging.
	Displays when the line is in use. Flashes when there is an incoming call.
	Flashes when you have a new voicemail message. (This is a network service)
	Displays when you have new missed calls, or the call log is being viewed.*
	Displays when the phonebook is accessed.
	Displays when the alarm is set.
	Displays when handset ringer is turned off.
	Displays when the handset is registered and within range of the base station. Blinks when the handset is out of range or is searching for a base.
	Displays when the answering machine is on. Flashes slowly when there are new answering machine message(s) or when the answering machine memory is full.
OK	Turns on when confirmation of selection or programming is available.
BACK	Turns on during phonebook editing mode to delete the last digit. Turns on during menu mode when you can return to the previous state or previous step.
	Turns on when the screen display is on.

*You must subscribe to Voicemail service or Caller ID from your network providers for this feature to work. You may need to pay a subscription fee.

7.3 Base Unit (See P3)

#	Icon	Meaning
12		Lights up in Green when the answering machine is on. Flashes if there are new messages. Flashes rapidly if the answering machine memory is full.
13		Lights up in Red when a handset is on the base to indicate it is charging.
14		Press to find/page all registered handsets. Press the button again, or any key on the handset to turn off the page signal. Press and hold to start registration process.

7.4 Menu Map and Menu

- From the home screen of the handset, press /OK to access **"ANS. SYSTEM"**, the first option in the main menu list.
- Press  or  to go to other options in the menu list.
- Press /OK to enter a sub-menu or function.
- Press  to go back to the previous level.
- Press  to cancel the current operation and return to the home screen.

Note: If you do not press any key on the handset for 15 seconds, the display will automatically return to the home screen.

ANS. SYSTEM	PHONEBOOK	CLOCK&ALARM	HANDSET OPTS	SETTINGS
PLAY	NEW ENTRY	DATE & TIME	HANDSET NAME	CHANGE PIN
DELETE ALL	VIEW ENTRIES	SET FORMAT	RINGER&TONES	REGISTRATION
ANS. ON/OFF	EDIT ENTRY	TIME FORMAT	RING VOLUME	DEREGISTER
ANNOUNCEMENT	DELETE	DATE FORMAT	RING TONE	RESET
ANSWER MODE	DELETE ALL	ALARM	KEY TONE	RECALL TIME
ANS. SETTING	DIRECT MEM.	ALARM MELODY	LANGUAGE	
RING DELAY			AUTO HANG-UP	
REMOTE ACC.				
LANGUAGE				

7.5 Text and Number Entry

You can select different characters by using repeated presses of the alphanumeric keypad. This will be helpful when storing a name in the phonebook or renaming your handset. The characters are printed on the keys.

For example, to enter the name **Tom**:

T	Press 8 once
O	Press 6 three times
M	Press 6 once

In editing mode, a cursor is displayed to indicate the current text entry position. It is positioned at the right of the last character entered.

Writing Tips:

- Once a character is selected, the cursor will move to the next position after a short pause.
- Press ↵/⌫ to delete the last letter or number.

Key	1st press	2nd press	3rd press	4th press	5th press	6th press
1	Space	1	_	<	>	*
2	A	B	C	2		
3	D	E	F	3		
4	G	H	I	4		
5	J	K	L	5		
6	M	N	O	6		
7	P	Q	R	S	7	
8	T	U	V	8	?	
9	W	X	Y	Z	9	
0	0	-	/	Space	#	+
*	*					
#	#					

8. USING YOUR PHONE

8.1 Make a Call

8.1.1 Pre-dialling

- Enter the phone number (maximum 24 digits). If you make a mistake, press \rightarrow/\boxtimes to delete the last entered number.
- Press \hookleftarrow to dial the phone number.

8.1.2 Direct Dialling

- Press \hookleftarrow on your Handset.
- Dial the number.

8.1.3 Call from the Redial List

- Press \bullet in standby mode.
 - > The last number dialled is displayed.
- Press Δ/∇ to select the desired entry in the redial list and then press \hookleftarrow to dial out the selected redial number.

8.1.4 Call from the Call Log

- Press $+/\text{person}/\Delta$ in standby mode.
- Press Δ/∇ to select the desired entry in the call log and then press \hookleftarrow to dial out the selected call log number.

Note: You need to subscribe to Caller Line Identification service to be able to see the caller's number or name in the call log.

8.1.5 Call from the Phonebook

- Press $-/\text{person}/\nabla$ in standby mode.
- Press Δ/∇ to select the desired entry in the phonebook and then press \hookleftarrow to dial out the selected phonebook number.

8.2 Answer and End a Call

- When the phone rings, press \hookleftarrow on your handset.
- To end a conversation, press end call on your handset.

Warning: When the handset is ringing, please do not hold it too close to your ear as the volume of the ringing tone may damage your hearing.

Note: You can simply place the handset back on its base station to end the call, provided you have not deactivated the **Auto hang-up** feature.

8.3 Handset Speakerphone

During a call, you can press speakerphone to alternate between hands-free speakerphone and handset earpiece.

8.4 Adjust Earpiece Volume

There are **5** levels of earpiece volume on your Handset.

- During a call, press Δ/∇ to select from **"VOLUME 1"** to **"VOLUME 5"**.
 - > The current setting is shown.
 - > When you end the call, the setting will remain at the last selected level.

8.5 Adjust Speaker Volume

There are **5** levels of speaker volume.

- During a handsfree call, press Δ/∇ to select from **"VOLUME 1"** to **"VOLUME 5"**.
 - > The current setting is shown.
 - > When you end the call, the setting will remain at the last selected level.

8.6 Mute/Unmute the Microphone

- When the microphone is muted, the handset displays **"MUTE ON"** and your caller cannot hear you.
- During a call, press $\hookrightarrow/\boxtimes$ to turn on/off the microphone.

8.7 Paging

The paging feature enables you to locate a missing handset if the handset is in range and contains charged batteries.

- Press the ☎ key under the base unit.
 - > All the registered handsets that are in range will start to ring.

You can stop the paging by pressing any key on a handset or the ☎ key under the base unit again.

8.8 Switching the Handset On/Off

Press and hold ☎ on your Handset for more than 2 seconds to switch the handset on or off in standby mode.

> When first turned on, the display shows **"SEARCHING..."** until the handset finds the base.

Note: You can switch the handset off to save battery life, if the handset is not on the base.

IMPORTANT:

When the handset is **"OFF"**, it cannot be used for making calls including emergency calls. It will not ring when there is an incoming call.

To answer a call, you will need to switch it back on and it may take some time for the handset to re-establish a radio link with the base unit.

8.9 To Lock/Unlock the Keypad

You can lock the keypad to avoid making calls or pressing the keys accidentally.

- In standby mode, press and hold $\ast/\text{🔒}$ for 2 seconds to lock the keypad.
 - > The handset displays **"KEYS LOCKED"**.
- To turn the keypad lock off, press and hold $\ast/\text{🔒}$ again.

Note: Incoming calls can still be answered even if the keypad is locked.

8.10 Make an Internal Call (Multi - handset models only)

The system allows an intercom call between any two handsets registered to the same base. It also allows you to transfer external calls from one handset to another and set up a 3-way conference with two handsets and an external call.

8.11 Initiate an Intercom Call

- In standby mode, press INT.
 - > Intercom is established immediately if there are only 2 registered handsets.
 - > If there are more than 2 registered handsets, the handset numbers which are available for intercom will be displayed.
- Press the handset number you wish to call or press * to call all handsets.
- Press C on a called handset to answer the internal call, where both internal callers can talk.
- To end the intercom call, press D on either handset.

Note:

- You can cancel the intercom call before it is answered by pressing INT or D on the originating handset.
- If there is no answer from the called handset within one minute, the paging will be cancelled automatically.
- If no other handset is registered to the base, 4 beeps will be heard and it will return to standby mode.

8.12 Answer an External Call during an Intercom Call

You will hear an alert tone when you receive an incoming external call during an intercom call and you can choose from the following options:

- Press D to cancel the intercom call and let the handsets receive normal incoming ringing.
- Press C to answer the incoming call and end the intercom call.
- Press INT to answer the incoming call and put the intercom call on hold.
- When the incoming external call is connected and the intercom call is on hold, press and hold INT to start a three-party conference call with both the incoming and the intercom parties.
- When the handset is connected to an external call, you can press C to enter into a three-party conference call directly.

8.13 Initiate an Intercom during a Call

You can intercom with another system handset during a call, or invite another system handset to join in a conference call with you and the external caller.

- During the call, press INT to put the external call on hold.
 - > Intercom is established immediately if there are only 2 registered handsets.
 - > If there are more than 2 registered handsets, the handset numbers which are available for intercom will be displayed.
- Press the handset number you wish to call or press */☐ to call all handsets.

Note: If there is no answer from the called handset, or you wish to cancel the intercom call before it is answered, press INT to return to the external call.

- Press C on the called handset to answer the internal call, where both internal callers can talk.
- When the intercom call is connected, you can choose from the following options on the originating handset:
 - > Press and hold INT for 2 seconds to connect both handsets to the call in conference mode.
 - > Press C on either handset to terminate the intercom on that handset, and leave the external call connected to the other handset.

8.14 Transfer an External Call to another Handset

- During the call, press **INT** to put the external call on hold.
 - > Intercom is established immediately if there are only 2 registered handsets.
 - > If there are more than 2 registered handsets, the handset numbers which are available for intercom will be displayed.
- Press the handset number you wish to call or press ***/☎** to call all handsets.

Note: If there is no answer from the called handset, or you wish to cancel the intercom call before it is answered, press **INT** to return to the external call.

- Press **(** on the called handset to answer the internal call, where both internal callers can talk.
- Press **)** on the originating handset to transfer the external call to the called handset.
 - > The external call is transferred.

9. DIRECT ACCESS MEMORY

In addition to the phonebook memory, there are 2 direct access memories (Keys 1 & 2) on the handset. A long press on the keys in standby mode will automatically dial the stored phone number.

9.1 Add Direct Access Memory

- From the home screen, press **☐/OK**.
- Press **△/▽** to **"PHONEBOOK"** and then press **☐/OK** to select.
- Press **△/▽** to **"DIRECT MEM."** and then press **☐/OK** to select.
- Press **△/▽** to **"KEY 1"** or **"KEY 2"** and then press **☐/OK** to select.
 - > The stored name is displayed, or **"NO NUMBER"** if it is empty.
- Press **☐/OK** to enter the **"DIRECT MEM."** menu to add/edit the name or number.
- Press **☐/OK** again to select **"EDIT NUMBER"**.
 - > The display shows the currently stored name or just **"ENTER NAME"** if it is empty.
- Edit or enter the name of your contact and press **☐/OK**.

If you make a mistake, press **↶/✕** to delete the last character entered.

> The display shows the currently stored number or just **"ENTER NUMBER"** if it is empty.

- Edit or enter the number of your contact and press **☐/OK**.

If you make a mistake, press **↶/✕** to delete the last digit entered.

> A confirmation tone is played.

- Press **)** to return to standby mode.









9.2 Delete Direct Access Memory

- From the home screen, press **☐/OK**.
- Press **△/▽** to **"PHONEBOOK"** and then press **☐/OK** to select.
- Press **△/▽** to **"DIRECT MEM."** and then press **☐/OK** to select.
- Press **△/▽** to **"KEY 1"** or **"KEY 2"** and then press **☐/OK** to select.
 - > **"NO NUMBER"** is displayed if it is empty. Otherwise, the stored name is displayed.
- Press **☐/OK** to enter the menu options.
- Press **△/▽** to **"DELETE"** and then press **☐/OK** to select.
 - > **"CONFIRM?"** is displayed.
- Press **☐/OK** again to confirm.
 - > A confirmation tone is played.
- Press **)** to return to standby mode.

10. PHONEBOOK









The unit can store up to 200 phonebook entries. Each phonebook entry can have a maximum of 24 digits for the phone number and 12 characters for the name.

10.1 Store a Contact in the Phonebook

- From the home screen, press /OK.
- Press  to "PHONEBOOK" and then press /OK to select.
- Press /OK to select "NEW ENTRY".
 - >The screen displays "ENTER NAME".
- Enter the name of the contact (maximum 12 characters) using the keypad.
- If you make a mistake, press /☒ to delete the last character entered.
- Press /OK to confirm the name entry.
 - >The screen displays "ENTER NUMBER".
- Enter the number of the contact (maximum 24 digits) using the keypad.
- If you make a mistake, press /☒ to delete the last digit entered.
- Press /OK to confirm.
 - >A confirmation tone is played.
- Press  to return to standby mode.

Note: You cannot store a new phonebook entry when the memory is full. In this case, you have to delete existing entries to make space for new ones.









10.2 Access the Phonebook

- From the home screen, press /☒ to open the phonebook list.
- Alternatively, from the home screen, you can press /OK, then  to "PHONEBOOK", then press /OK and  to "VIEW ENTRIES", then press /OK to open the phonebook list.
 - >The phonebook entries are listed in alphabetical order.
- Press  to scroll through the list of entries.
- Press /☒/P to view the details of the selected entry.
- Press  to return to standby mode.

Note: Instead of pressing  to browse the phonebook entries, you can press the numeric key corresponding to the first letter of the entry you wish to locate.

For example, pressing 2 will show the first entry starting with A. Pressing 2 again will show the first entry starting with B, and so on..., and then press  to find the entry you want.

10.3 Modify a Phonebook Entry

- From the home screen, press /☒ to open the phonebook list.
- Press  to select the entry you want to modify.
- Press /OK to open the phonebook menu options.
- Press  to "EDIT ENTRY" and then press /OK to select.
 - >The current name is displayed.
- Edit the name using the keypad, using /☒ to delete characters.
- Press /OK to confirm.
- Edit the number and then press /OK to confirm.
 - >A confirmation tone is played.
- Press  to return to standby mode.

10.4 Delete a Phonebook Entry

- From the home screen, press **−/👤/▽** to open the phonebook list.
- Press **△/▽** to select the entry you want to delete.
- Press **☰/OK** to open the phonebook menu options.
- Press **△/▽** to **"DELETE"** and then press **☰/OK** to select.
 - > **"CONFIRM?"** is displayed.
- Press **☰/OK** again to confirm.
 - > A confirmation tone is played.
- Press **Ⓜ** to return to standby mode.

10.5 Delete All Entries from the Phonebook List

- From the home screen, press **−/👤/▽** to open the phonebook list.
- Press **☰/OK** to open the phonebook menu options.
- Press **△/▽** to **"DELETE ALL"** and then press **☰/OK** to select.
 - > **"CONFIRM?"** is displayed.
- Press **☰/OK** again to confirm.
 - > A confirmation tone is played.
- Press **Ⓜ** to return to standby mode.

11. CALLER DISPLAY (NETWORK DEPENDENT)

If you have subscribed to the Calling Line Identification (CLI) service with your network service provider, the phone number of your caller will appear on the handset display when there is an incoming call and then stored in your **Call Log**.

If the caller's number is stored in your phonebook along with a name, the name will appear on the handset display when the call is received and in the **Call Log**.

Note: If the call is from someone whose number is unavailable (e.g. an international call or from a private exchange), the handset will display **"UNAVAILABLE"** when you receive the call and in the **Call Log** afterwards. If the call is from someone whose number is withheld, the handset will display **"WITHHELD"** when you receive the call and in the **Call Log** afterwards.

If you have not subscribed to the Caller Line Identification service, the handset will display **"UNKNOWN"** when you receive the call and it will not be saved in the **Call Log**.

Information about incoming calls varies by country and network operators.

11.1 Call Log

The **Call Log** stores the last 20 external calls whether or not you have answered the call.

Only the most recent call is saved if there are repeat calls from the same number.

When the **Call Log** is full, the next new call will replace the oldest entry.

11.1.1 Access the Call Log

- From the home screen, press **+/👤/△**.
- Press **△/▽** to browse through the call list.
 - > The calls are displayed in chronological order with the most recent call at the top of the list.

11.1.2 Save a Call Log Entry into the Phonebook

- From the home screen, press **+/#/△**.
- Press **△/▽** to select an entry and then press **☐/OK**.
- Press **M** again to select **"SAVE NUMBER"**.
- Enter the name of the contact (maximum 12 characters) and then press **☐/OK** to save.
- Edit the number (if necessary) and then press **☐/OK** to save the entry.
 - > A confirmation tone is played.
- Press **Ⓜ** to return to standby mode.

11.1.3 Delete a Call Log Entry

- From the home screen, press **+/#/△**.
- Press **△/▽** to select an entry and then press **☐/OK**.
- Press **△/▽** to **"DELETE"** and then press **☐/OK** to select.
 - > **"CONFIRM?"** is displayed.
- Press **☐/OK** again to confirm.
 - > A confirmation tone is played.
- Press **Ⓜ** to return to standby mode.

11.2 Delete All Entries in the Call Log

- From the home screen, press **+/#/△**.
- Press **☐/OK**.
- Press **+/-** to **"DELETE ALL"** and then press **☐/OK** to select.
 - > **"CONFIRM?"** is displayed.
- Press **☐/OK** again to confirm.
 - > A confirmation tone is played.

11.3 Redial List

The redial list stores the last 10 numbers dialled. A maximum of 24 digits can be displayed for each entry.

11.3.1 Access the Redial List

- From the home screen, press **Ⓜ**.
- Press **△/▽** on to browse the redial list.
 - > The last dialled number will appear first in the redial list.
 - > If the number has more than 14 digits press **#/Ⓜ/P** to see other digits.

11.3.2 Save a Redial Number into the Phonebook

- From the home screen, press **Ⓜ**.
- Press **△/▽** to select an entry and press **☐/OK**.
- Press **△/▽** again to select **"SAVE NUMBER"**.
- Enter the name of the contact (maximum 12 characters) and then press **☐/OK**.
- Edit the number (if necessary) and then press **☐/OK** to save.
 - > A confirmation tone is played.
- Press **Ⓜ** to return to standby mode.

11.3.3 Edit a Redial Number

- From the home screen, press **⏻**.
- Press **▲/▼** to select an entry and then press **⏻/OK**.
- Press **▲/▼** to **"EDIT ENTRY"** and then press **⏻/OK** to select.
- Edit the number and press **⏻/OK** to confirm.
 - > A confirmation tone is played.
- Press **⏻** to return to standby mode.

11.3.4 Delete a Redial Number

- From the home screen, press **⏻**.
- Press **▲/▼** to select an entry and then press **⏻/OK**.
- Press **▲/▼** to **"DELETE"** and then press **⏻/OK** to select.
 - > **"CONFIRM?"** is displayed.
- Press **⏻/OK** again to confirm.
 - > A confirmation tone is played.
- Press **⏻** to return to standby mode.

11.3.5 Delete All Entries from the Redial List

- From the home screen, press **⏻**.
- Press **⏻/OK**.
- Press **▲/▼** to **"DELETE ALL"** and then press **⏻/OK** to select.
 - > **"CONFIRM?"** is displayed.
- Press **⏻/OK** again to confirm.
 - > A confirmation tone played.

12. CLOCK AND ALARM SETTINGS

12.1 Date and Time Settings









If you have subscribed to the Calling Line Identification service, the time and date settings will be automatically updated by the network when you receive an incoming call, but you may still need to set the correct year.

You can also set the date and time manually.

- From the home screen, press **⏻/OK**.
- Press **▲/▼** to **"CLOCK&ALARM"** and then press **⏻/OK** to select.
- Press **⏻/OK** again to select **"DATE & TIME"**.
 - > The last stored date is displayed, with the third digit of the year flashing.
- Enter the current date and press **⏻/OK** to confirm.
 - > Enter 03 May 2012 as [1], [2], [0], [5], [0], [3].
 - > If you make a mistake, press **↵/✕** to delete the last digit entered.
- Enter the current time and press **⏻/OK** to confirm. The default time format is 24 HOURS. (To change time format, see Change the Date Format on page 51.)
 - > For 24-hour format, enter 1:30pm as [1], [3], [3], [0].
 - > For 12-hour format, enter the time and then press **+** to select am, or press **-** to select pm.
 - > If you make a mistake, press **↵/✕** to delete the last digit entered.
 - > A confirmation tone is played.
- Press **⏻** to return to standby mode.











12.1.1 Change the Time Format

The time can be displayed either as 12-hour or 24-hour. The default setting is 24 HOURS.

- From the home screen, press /OK.
- Press  to "**CLOCK&ALARM**" and then press /OK to select.
- Press  to "**SET FORMAT**" and then press /OK to select.
- Press /OK again to select TIME FORMAT.
 - > The current setting is displayed.
- Press  to select 12 HOURS or 24 HOURS and then press /OK to confirm.
 - > A confirmation tone is played.
- Press  to return to standby mode.

12.1.2 Change the Date Format

The date can be displayed either as Month/Day or Day/Month. The default setting is DD/MM.









- From the home screen, press /OK.
- Press  to "**CLOCK&ALARM**" and then press /OK to select.
- Press  to "**SET FORMAT**" and then press /OK to select.
- Press  to "**DATE FORMAT**" and then press /OK to select.
 - > The current setting is displayed.
- Press  to select "**DD/MM**" or "**MM/DD**" and then press /OK to confirm.
 - > A confirmation tone is played.
- Press  to return to standby mode.

12.2 Alarm Settings

An alarm can be set on a handset, to sound at a set time only once or repeated each day.









When an alarm is set, the alarm icon is shown on the handset display.

When the alarm time is reached, the handset will flash "**-ALARM-**" on the display and sound an alarm for 1 minute, at the same volume setting as the handset ringer. If the ringer is off, it will ring at volume setting 1. When the alarm rings, you can press any key on the handset to stop the ringing, even if the keylock is activated.

- From the home screen, press /OK.
- Press  to "**CLOCK&ALARM**" and then press /OK to select.
- Press  to "**ALARM**" and then press /OK to select.
- Press  to an alarm option.
 - > **OFF**: Turn alarm off
 - > **ONCE**: The alarm sounds once at the set time.
 - > **DAILY**: The alarm sounds daily at the set time.
- Press /OK to select the option.
- If "**ONCE**" or "**DAILY**" is selected, enter the desired hour and minute.
- Press + to select am, or press- to select pm if the time is in 12-hour format.
- Press /OK to confirm the alarm setting.
 - > A confirmation tone is played.
- Press  to return to standby mode.

12.2.1 Set the Alarm Tone

You can select from 3 alarm melodies.









- From the home screen, press /OK.
- Press  to **"CLOCK&ALARM"** and then press /OK to select.
- Press  to **"ALARM MELODY"** and then press /OK to select.
- Press  to select the desired alarm tone (each tone will sound as it is selected) and then press /OK to confirm.
 - >A confirmation tone is played.
- Press  to return to standby mode.

13. SETTINGS

Your phone comes with a selection of settings that you can change to personalise your phone to the way you like it to work.

13.1 Set the Ring Volume











You can set the handset ringer volume from Level 1 to Level 4 or turn the ringer off.

- From the home screen, press /OK.
- Press  to **"HANDSET OPTS"** and then press /OK to select.
- Press  to **"RINGER&TONES"** and then press /OK to select.
- Press /OK again to select **"RING VOLUME"**.
- Press  to select the desired setting (each volume level will play as it is selected) and then press /OK to confirm.
 - >A confirmation tone is played.
- Press  to return to standby mode.

Note: Press and hold  to switch the ringer on and off when the handset is in standby mode. The ringer off icon displays on the screen when ringer off feature is activated.











13.2 Set the Ring Tone

You can select from 10 ringer melodies for both internal and external calls.

- From the home screen, press /OK.
- Press  to **"HANDSET OPTS"** and then press /OK to select.
- Press  to **"RINGER&TONES"** and then press /OK to select.
- Press  to **"RING TONE"** and then press /OK to select.
- Press  to select the desired ringer melody from 1 to 10 (each melody will play as it is selected) and then press /OK to confirm.
 - >A confirmation tone is played.
- Press  to return to standby mode.







13.3 Set the Key Tone

The handset emits a tone with each key press. You can choose to turn this tone on or off. The default setting is **"ON"**.

- From the home screen, press /OK.
- Press  to **"HANDSET OPTS"** and then press /OK to select.
- Press  to **"RINGER&TONES"** and then press /OK to select.
- Press  to **"KEY TONE"** and then press /OK to select.
- Press  to select **"ON"** or **"OFF"** and then press /OK to confirm.
 - >A confirmation tone is played.
- Press  to return to standby mode.









13.4 Rename the Handset

You can personalise your handset by changing the name shown on the handset in standby mode.

- From the home screen, press /OK.
- Press  to **"HANDSET OPTS"** and then press /OK.
- Press /OK to select **"HANDSET NAME"**.
- The current handset name is displayed.
- Press  to delete the letters one by one and enter the new name (maximum 10 characters).
- Press /OK to confirm.
 - >A confirmation tone is played.
- Press  to return to standby mode.

13.5 Set the Display Language









You can change the display language on your handset.

- From the home screen, press /OK.
- Press  to **"HANDSET OPTS"** and then press /OK to select.
- Press  to **"LANGUAGE"** and then press /OK to select.
- Press  to select your preferred language and then press /OK to confirm.
 - >A confirmation tone is played.
- Press  to return to standby mode.

Note: Once the display language is set, the handset will switch to display in the selected language immediately.

13.6 Set Auto Hang-up

This function enables you to end a call automatically by simply placing the handset back on the base unit (main Eclipse handset) or charging pod (additional handsets). By default, the Auto Hang-up feature is ON, but it can be turned off.

- From the home screen, press /OK.
- Press  to **"HANDSET OPTS"** and then press /OK to select.
- Press  to **"AUTO HANG-UP"** and then press /OK to select.
- Press  to select **"ON"** or **"OFF"** and then press /OK to confirm.
 - >A confirmation tone is played.
- Press  to return to standby mode.

13.7 Handset Registration







IMPORTANT: When you purchase your unit, all handsets are already registered to your base, so you do not need to register them.

Handset registration is only necessary when you buy extra handsets or if a handset has become faulty. You can register up to four handsets to one base station, with each handset's number (1 to 4) shown on its display.

Note: Each handset can only be registered to one base.

You need to enter the Master PIN before you can register or deregister handsets. The default Master PIN is **0000**.

13.8 Register Additional Handsets









- Press and hold the  key under the base unit for approximately 5 seconds.
 - >The message indicator on the base will flash for up to 1 minute, while it is in registration mode.
- On the handset, press .
- Press  to **"SETTINGS"** and then press  to select.
- Press  to **"REGISTRATION"** and then press  to select.
- Enter the Master PIN and then press  to confirm.

Note: After entering the Master PIN,

- >**WAITING** flashes on the screen.
- >A confirmation tone is played to indicate successful registration, and the handset returns to standby mode, with its handset number displayed.
- >If no base is found with the entered PIN, error tones are played to indicate failed registration and **"PLS REG H/S"** is displayed on the screen. You will need to repeat from step 1 above.
- >During steps 2-5, if no key is pressed on the handset within 10 seconds, the registration procedure will be aborted. If this happens, repeat from step 1 above.

13.9 Deregister your Handset

You can deregister the handset you are using, or any other handset registered to the same base. The default Master PIN is 0000.

- From the home screen, press .
- Press  to **"SETTINGS"** and then press  to select.
- Press  to **"DEREGISTER"** and then press  to select.
- Enter the Master PIN and then press  to confirm.
- Press  to select the handset number you want to deregister and then press  to confirm, or press  to cancel the deregistration procedure.

Note: After confirming the handset you want to remove:

- >A confirmation tone is played to indicate successful deregistration.
- >**"PLS REG H/S"** is displayed on the home screen of the unregistered handset.
- >If no handset key is pressed within 10 seconds, the procedure will abort and the handset returns to standby mode.

13.10 Change the Master PIN

The Master PIN is used for registration/deregistration of handsets and for accessing the answering machine remotely. The default Master PIN number is 0000. The maximum length of the Master PIN is 8 digits.

Note: If you forget your PIN code, you can reset it to its default 0000 using a handset Reset.

- From the home screen, press **⏏**/OK.
- Press **▲/▼** to **"SETTINGS"** and then press **⏏**/OK to select.
- Press **⏏**/OK to select **"CHANGE PIN"**.
- Enter the current Master PIN and then press **⏏**/OK to confirm.
 - >The PIN will be shown as asterisks (*) on the screen as you enter them.
- Enter the new PIN and then press **⏏**/OK to confirm.
 - >A confirmation tone is played.
- Press **⏏** to return to the home screen.

13.11 Set the First Ring (for Additional Handsets Only)

If you have subscribed to Caller Line Identification service and do not wish to hear the phone ring before the caller identification is displayed, you can set the **"FIRST RING"** to **"OFF"**.

- From the home screen of your additional handset, press **⏏**/OK.
- Press **▲/▼** to **"ADVANCED SET"** and then press **⏏**/OK to select.
- Press **▲/▼** to **"FIRST RING"** and then press **⏏**/OK to select.
- Press **▲/▼** to select **"ON"** or **"OFF"** and then press **⏏**/OK to confirm.
 - >A confirmation tone is played.
- Press **⏏** to return to standby mode.

13.12 Change the Recall Time

You may need to press **(** to send a Flash signal (also called Recall or Timed Break Recall) if you are connected to a PBX or using certain network services. You should normally leave the Recall Time at its default setting, Short (100ms). However, it can be changed to Medium (270ms) or Long (600ms) if your telephone is connected to a PBX that requires a different recall time.

- From the home screen, press **⏏**/OK.
- Press **▲/▼** to **"SETTINGS"** and then press **⏏**/OK to select.
- Press **▲/▼** to **"RECALL TIME"** and then press **⏏**/OK to select.
- Press **▲/▼** to select **"SHORT"**, **"MEDIUM"** or **"LONG"** and then press **⏏**/OK to confirm.
 - >A confirmation tone is played.
- Press **⏏** to return to standby mode.

13.13 Reset the Unit

You can reset your phone to its default settings with this feature.

Note: Upon reset, all your personal settings, call log and redial list entries will be deleted and the phone will return to its default settings, including the Master PIN. However, your phonebook will remain unchanged after reset and any recorded messages will remain unchanged, while all other settings will be reset.

- From the home screen, press **⏏**/OK.
- Press **▲/▼** to **"SETTINGS"** and then press **⏏**/OK to select.
- Press **▲/▼** to select **"RESET"** and then press **⏏**/OK to select.
- Press **⏏**/OK again to confirm.
 - >A confirmation tone is played and the unit is reset to its default settings.

14. ANSWERING MACHINE







Your phone includes a telephone answering machine that records unanswered calls when it is on. The answering machine can store up to 59 messages within the maximum recording time of approximately 30 minutes and each message can be up to 3 minutes long.

When the answering machine is on, calls are answered after the set **"RING DELAY"**.

If you have selected **"RECORD MSGS"** then the caller can leave you a message after hearing your announcement.

If you have selected **"ANSWER ONLY"** mode, the caller can only listen to your announcement but cannot leave you a message. If the answering machine memory is full, the answering machine LED on the base flashes rapidly, the answering machine icon on the handset flashes slowly and the **"ANSWER ONLY"** announcement will be played to new callers. You will have to delete some messages before any new ones can be recorded.

14.1 Turning the Answering Machine On/Off

- From the home screen, press /OK.
- Press /OK again to select **"ANS. SYSTEM"**.
- Press  to **"ANS. ON/OFF"** and then press /OK to select.
- Press  to select **"ON"** or **"OFF"** and then press /OK to confirm.
 - > A confirmation tone is played.
- Press  to return to standby mode.







Note: If the answering machine is **"OFF"** and the Master PIN is still set at its default **0000**, the answering machine will not answer any incoming calls.

However, if the Master PIN has been changed and Remote Access is activated, it will answer incoming calls after 14 rings to allow remote access, and the **"ANSWER ONLY"** announcement will play.

14.2 Answer Mode

The phone comes with two pre-recorded announcements for the respective answer modes: **"ANSWER ONLY"** and **"RECORD MSGS"**. By default, the answer mode is **"RECORD MSGS"** which allows a caller to leave a message on the answering machine after hearing the announcement. This can be changed to **"ANSWER ONLY"** mode, which does not allow callers to leave any messages on the answering machine after hearing the announcement.

14.2.1 Set Answer Mode

- From the home screen, press /OK.
- Press /OK again to select **"ANS. SYSTEM"**.
- Press  to **"ANSWER MODE"** and then press /OK to select.
- Press  to select **"ANSWER ONLY"** or **"RECORD MSGS"** and then press /OK to confirm.
 - > A confirmation tone is played.
- Press  to return to standby mode.

14.3 Answering Machine Settings

14.3.1 Set the Ring Delay

You can select the number of rings before the answering machine answers a call and starts playing the announcement. You can set the delay from 2 to 7 rings or **"TOLL SAVER"**.

- From the home screen, press **⏏/OK**.
- Press **⏏/OK** again to select **"ANS. SYSTEM"**.
- Press **▲/▼** to **"ANS. SETTING"** and then press **⏏/OK**.
- Press **⏏/OK** to select **"RING DELAY"**.
- Press **▲/▼** to select **"2 RINGS"** – **"7 RINGS"** or **"TOLL SAVER"** and then press **⏏/OK** to confirm.
 - >A confirmation tone is played.
- Press **⏏** to return to standby mode.

Note: If you select **"TOLL SAVER"** the answering machine will answer an incoming call on the fifth ring if you have no new messages and on the third ring if you do.

When you call your answering machine to check messages, if it does not answer on the third ring, then you can hang up immediately, knowing that you have no new messages. This feature can save you the cost of a long-distance call when you check your messages remotely.

14.3.2 Activate/Deactivate Remote Access

- From the home screen, press **⏏/OK**.
- Press **⏏/OK** again to select **"ANS. SYSTEM"**.
- Press **▲/▼** to **"ANS. SETTING"** and then press **⏏/OK** to select.
- Press **▲/▼** to **"REMOTE ACC."** and then press **⏏/OK** to select.
- Press **▲/▼** to select **"ACTIVATE"** or **"DEACTIVATE"** and then press **⏏/OK** to confirm.
 - >A confirmation tone is played.
- Press **⏏** to return to standby mode.

Note: Once the remote control access is activated, you can check the messages on your answering machine when you are away from home, by calling from another phone.

The Master PIN is used for accessing the answering machine remotely. If your answering machine is off, you must change your Master PIN from its default 0000 before you can use the remote access feature to turn on your answering machine.

14.3.3 Change the Voice Language

You may be able to select a different language for the answering machine's pre-recorded announcements.

- From the home screen, press **⏏/OK**.
- Press **⏏/OK** again to select **"ANS. SYSTEM"**.
- Press **▲/▼** to **"ANS. SETTING"** and then press **⏏/OK** to select.
- Press **▲/▼** to **"LANGUAGE"** and then press **⏏/OK** to select.
- Press **▲/▼** to select your preferred language (if available) and then press **⏏/OK** to confirm.
 - >A confirmation tone is played.
- Press **⏏** to return to standby mode.

14.4 Message Playback

When there are new messages on the answering machine, ✉ flashes on the handset screen.

- From the home screen, press **☰/OK**.
- Press **☰/OK** again to select **"ANS. SYSTEM"**.
- Press **☰/OK** again to select **"PLAY"**.
 - > Your messages will automatically playback through the handset's speakerphone.
 - > The display will show the message number and the date and time of the call.
 - > Press **🔇** to listen to your messages privately through the earpiece of your handset.
- During playback, press **☰/OK** and then press **▲/▼** to access the following options:

REPEAT	Repeat the currently playing message
NEXT	Play the next message
PREVIOUS	Play the previous message
DELETE	Delete the current message

Note: To return to the screen showing the message number and date/time, press **↶/✕**.

- Press **📞** to return to standby mode.

14.5 Delete All Messages

Note: Only old messages can be deleted. New messages must be played before they can be deleted.

- From the home screen, press **☰/OK**.
- Press **☰/OK** again to select **"ANS. SYSTEM"**.
- Press **▲/▼** to select **"DELETE ALL"** and then press **☰/OK**.
- Press **☰/OK** again to confirm.
 - > A confirmation tone is played.
- Press **📞** to return to standby mode.

14.6 Announcement

When the answering system answers a call, the pre-recorded announcement is played to the caller unless you have recorded your own announcement.

The phone comes with two pre-recorded announcements for the respective answer modes: **"ANSWER ONLY"** and **"RECORD MSGS"**. By default, the answer mode is **"RECORD MSGS"**, which allows a caller to leave a message on the answering machine after hearing the announcement. This can be changed to **"ANSWER ONLY"** mode, which does not allow callers to leave any messages on the answering machine after hearing the announcement.

14.6.1 Record a Personal Announcement

You can choose to replace the default announcement with your own personal announcements.

Note: The maximum length of an announcement is 2 minutes.

- From the home screen, press **⏏**/OK.
- Press **⏏**/OK again to select **"ANS. SYSTEM"**.
- Press **△/▽** to **"ANNOUNCEMENT"** and then press **⏏**/OK to select.
- Press **△/▽** to select **"ANSWER ONLY"** or **"RECORD MSGS"** and then press **⏏**/OK to confirm.
- Press **△/▽** to **"RECORD ANNC"** and then press **⏏**/OK.
 - > A confirmation tone is played.
- Speak into the handset to start recording your new announcement and press **⏏**/OK again to end the recording.
 - > A confirmation tone is played.
- Press **⏏** to return to standby mode.

14.6.2 Listen to an announcement

- From the home screen, press **⏏**/OK.
- Press **⏏**/OK again to select **"ANS. SYSTEM"**.
- Press **△/▽** to **"ANNOUNCEMENT"** and then press **⏏**/OK to select.
- Press **△/▽** to select **"ANSWER ONLY"** or **"RECORD MSGS"**, and then press **⏏**/OK to confirm.
- Press **⏏**/OK to select **"PLAY"**.
 - > The announcement plays through the phone's speaker.
 - > Press **🔇** if you wish to listen to the announcement privately over the earpiece.
- Press **⏏** to return to standby mode.

14.6.3 Delete a Personal Announcement

If you want to return to using the default announcement, simply delete your personal announcement.

- From the home screen, press **⏏**/OK.
- Press **⏏**/OK again to select **"ANS. SYSTEM"**.
- Press **△/▽** to **"ANNOUNCEMENT"** and then press **⏏**/OK to select.
- Press **△/▽** to select **"ANSWER ONLY"** or **"RECORD MSGS"** and then press **⏏**/OK to confirm.
- Press **△/▽** to **"DELETE"** and press **⏏**/OK to confirm.
 - > The default pre-recorded announcement plays through the phone's speaker.
 - > Press **🔇** if you wish to listen to the announcement privately over the earpiece.
- Press **⏏** to return to standby mode.

14.7 Remote Access

The phone lets you listen to the messages on your answering machine, or otherwise operate your answering machine by calling in to your answering machine from another touch-tone phone. You need to enter a remote access code (same as your Master PIN) to access your answering machine remotely.

The remote access code is used to prevent unauthorised access of your answering machine.

Remote Access must be enabled if you want to use this feature.

14.7.1 Access the Answering Machine Remotely

- Dial your phone number from any touch-tone phone.
- When your answering machine answers your call and starts playing your announcement, press the # key.
>The announcement will stop playing.
- Enter your Remote Access Code (same as your Master PIN code) within 8 seconds using the numeric keypad on the touch-tone phone.

Note: that the answering machine will drop the call if you do not enter the Master PIN within 8 seconds.

- If the code is accepted, you will hear a confirmation tone.
- The answering machine will start to playback all the messages on your answering machine, beginning with new messages, or if there are no recorded messages you will hear four beeps.
- Use the keypad on the touch-tone phone to carry out the following operations:

Keys	
1	Repeat the previous message.
2	Playback messages / Repeat the current message.
3	Skip to the next message.
6	Delete the current message.
7	Turn on the answering machine in RECORD MSGS mode (main Eclipse handset) or ANSW.&RECORD mode (additional handsets).
8	Stop message playback.
9	Turn off the answering machine.

- When you have finished listening to your messages, simply hang up the phone to end.

Note:

If your answering machine is off but Remote Access is activated, the answering machine will answer your call after 14 rings, so that you can access it remotely, and the **"ANSWER ONLY"** announcement will play. If you enter an incorrect Remote Access Code, you will hear a triple-beep error tone, and you will need to enter the code again. If you enter the wrong Remote Code twice consecutively, the call will end automatically.

15. TROUBLESHOOTING

15.1 ALWAYS check that:

- You have followed all the steps listed in the user guide to install and set up your telephone.
- All connectors are securely inserted into their sockets.
- Mains power for the base unit is switched on at the socket.
- The handset's batteries are correctly and securely installed and are sufficiently charged.

15.2 Everyday use

"I cannot make or answer calls"

- If the handset's display is blank, it may have been switched off. Press and hold  on the Handset to switch it back on.
- Check that the base unit's mains power adapter is plugged in and power is switched on. The base unit needs mains power for normal operation of the phone – not just for charging the handset batteries.
- Make sure that you are using the telephone line cable supplied with your phone. Other telephone line cables might not work.
- Move the handset closer to the base unit.
- Check the Battery Level symbol on the display. If it is low, put the handset back on the base unit or charging pod to recharge the batteries.
- Switch off the power at the mains socket, wait for a short while and then switch it back on. This may solve the problem.

"I cannot make calls"

- If the handset display shows KEYS LOCKED, press and hold * to unlock it before you make a call.
- Only one handset (or the base unit) can be connected to an external line at a time. If the handset display shows, the base is already being used by either the answering machine or another handset.

"When I press on the keys, nothing happens"

- Make sure that the batteries are fitted in your handset. If the Battery Level symbol on the display shows 'low', put your handset back on the base unit or charging pod to charge.

"When I key in a number, it appears on the display, but I cannot make an external call"

- Try a different position for the base unit – somewhere higher if possible, or further away from other electrical equipment.

"The phone does not ring"

- Check that the base unit's mains power adapter is plugged in and power is switched on.
- The base unit needs mains power for normal operation of the phone – not just for charging the batteries.
- Make sure that you are using the telephone line cable that was supplied with your phone.
- Make sure that the ringer volume settings are not set to off. Increase the ringer volume settings.

"My call was cut off when I went out of range. Now I can't use my handset."

- Move the handset closer to the base unit before you try to make a call again.

"There is interference and noise on the line"

- Move the handset closer to the base unit, or to a different position.
- Try moving the base unit away from other electrical equipment, such as a television or a computer.
- You'll get the best reception if you place the base unit as high as possible. For example, in a two-floor building, the first-floor landing is an ideal place.

“The Caller Display feature isn’t working”

- You need to subscribe to the Caller Line Identification service from your network service provider.
- The caller may have withheld their number. Or they may be calling from a network that does not transmit the caller’s number (e.g. if they are making international calls.)

“When I try to make a call, I hear busy tone”

- If you’re using a multi-handset system, check whether another handset is already on a call.

“The volume in the earpiece is low when I’m on a call”

- Make sure you’re holding the earpiece correctly over your ear.
- Adjust the volume using Δ/∇

“I cannot store a phonebook entry”

- The maximum number of 200 phonebook entries on your Handset. You must delete existing entries to make space for new ones.

15.3 Intercom and transfer**“I can’t transfer a call”**

- Make sure that the other handset is in range of the base unit.
- Make sure that you have entered the correct number for the other handset.

15.4 Batteries**“The handset’s battery cells are running low within an hour or two”**

- Before you first use the handset, you must leave it to charge on the base unit or charging pod for at least 15 hours.
- You may need to replace the batteries.
- Check the connection between the base unit and the mains power socket.

“I try to recharge the batteries but I still get a warning that they are low”

- You need to replace the batteries. Dispose of used batteries safely – do not burn, immerse them in water, disassemble, or puncture the batteries.
- Do not use non-rechargeable batteries in your handset – they may explode, causing damage.

15.5 Registration**“I am not able to register another handset”**

- The maximum number of 4 handsets has been reached. You will need to unregister a handset in order to register a new one.

15.6 Answering Machine**“The Answering machine does not record messages”**

- Make sure that the answering machine is switched on.
- Make sure that the Answer Mode is set to RECORD MSGS.
- The memory may be full. If so, you will need to delete some messages.

“I cannot access my answering machine remotely”

- Make sure that Remote Access is activated.
- Make sure that you have entered the correct Remote Access PIN (same as your Master PIN).

15.7 If the fault persists...

- Disconnect all other instruments connected to the same line and try to make a call.
- Disconnect the base unit from the telephone line and plug a different phone. Try making a call. If this works, the line is OK.
- If the call does not work and you are using a two-way socket adapter, remove it and plug a telephone directly into the socket.
- If the call now works, the adapter may be faulty.
- If you cannot make a call, the fault may be on the exchange line. Contact the service provider.

16. CLEANING AND CARE

Do not clean any part of your unit with benzene, thinners or other solvent chemicals as this may cause permanent damage which is not covered by the Guarantee.

When necessary, clean it with a damp cloth.

Keep your phone system away from **hot, humid conditions or strong sunlight**, and **don't let it get wet.**

17. GUARANTEE AND SERVICE

The unit is guaranteed for 24 months from the date of purchase shown on your sales receipt. This guarantee does not cover any faults or defects caused by accidents, misuse, fair wear and tear, neglect, faults on the telephone line, lightning, tampering with the equipment, or any attempt at adjustment or repair other than through approved agents.

Please keep your sales (till) receipt this is your proof of guarantee.

17.1 While the unit is under Guarantee

- Disconnect the base unit from the telephone line and the mains electricity supply.
- Pack up all parts of your device, using the original package.
- Return the unit to the shop where you bought it, making sure you take your sales receipt.
- Remember to include the mains adapter.

17.2 After the Guarantee has expired

If the unit is no longer under Guarantee, contact us via **www.aegtelephones.eu**

This product works with rechargeable batteries only. If you put nonrechargeable batteries in the handset and place it on the base, the handset will be damaged and this is NOT covered under the warranty conditions.

18. CE DECLARATION

This product is in compliance with the essential requirements and other relevant provisions of the R&TTE directive 1999/5/EC.

The Declaration of conformity can be found on: **www.aegtelephones.eu**

19. DISPOSAL OF THE DEVICE (ENVIRONMENT)

At the end of the product lifecycle, you should not throw this product into the normal household garbage but bring the product to a collection point for the recycling of electrical and electronic equipments. The symbol on the product, user guide and/or box indicate this. Some of the product materials can be re-used if you bring them to a recycling point. By reusing some parts or raw materials from used products you make an important contribution to the protection of the environment. Please contact your local authorities in case you need more information on the collection points in your area.

Batteries must be removed before disposing of the device. Dispose of the batteries in an environmental manner according to your country regulations.

20. TECHNICAL DETAILS

Standard	Digital Enhanced Cordless Telecommunication (DECT)
Frequency range	1.88 to 1.9 GHz (bandwidth " 20 MHz)
Channel bandwidth	1.728 MHz
Operating range	Up to 300m outdoors; Up to 50m indoors
Operating time	Standby: 230 hours; Talking: 13 hours Battery charge time: 15 hours
Temperature range	Operating: 0°C to 40°C; Storage: -20°C to 60°C
Electrical power	Base unit power adapter: Ten Pao: S003IB0600050 & S003IV0600050 Input 100-240Vac 50-60Hz; Output 6VDC/500mA. Charger unit power adapter: Ten Pao: S003IB0600015 & S003IV0600015 Input 100-240Vac 50-60Hz; Output 6VDC/150mA. Battery information: 2 X 1.2V AAA size, 650mAh NiMH (Rechargeable)

© 2012 Binatone Electronics International Limited

All rights reserved

Subject to availability. Rights of modification reserved.

AEG is a registered trademark used under license from AB Electrolux (publ)

www.aegtelephones.eu

