



motorola

Corded Telephone



Model: CT330



ecomoto™

# Welcome...

## *to your new Motorola CT330 Corded Phone!*

- 10 two-touch and 2 direct dial memory keys for easy dialling.
- Bright backlit display.<sup>1</sup>
- Recall for network functions.
- Hold to put your caller on hold and listen to music.
- Redial the last number dialled at the touch of a button.
- Repeat call indicator to alert you if you miss a call from the same number more than once.
- Tone and Pulse dialling.
- Choose from 24 ringer melodies.
- Hands-free speakerphone.
- Ringer and hands-free volume control.
- Time and date facility.
- Alarm facility.
- Caller ID shows you the number of who is calling and stores the number of the last 34 callers in a Calls list.<sup>2,3</sup>

### **Need help?**

If you have any problems setting up or using your CT330, please contact Customer Services on Services on (65) 68412668.

Email: [support@alcom.com.sg](mailto:support@alcom.com.sg)

Alternatively, you may find the answer in the 'Help' section at the back of this guide.

<sup>1</sup>If no batteries are installed these functions will not operate.

<sup>2</sup>You must subscribe to your network provider's Caller ID or Call Waiting service for these features to work. A subscription fee may be payable.

<sup>3</sup>The entries are dynamically allocated to the missed and received calls lists.

This User Guide provides you with all the information you need to get the most from your phone.

Before you make your first call you will need to set up your phone. Follow the simple instructions in 'Getting Started', on the next few pages.

## IMPORTANT

Only use the telephone line cord supplied.

### Got everything?

- Corded handset and curly cord
- Corded base
- Telephone line cord
- 3 x AAA batteries



ECOMOTO: a convergence of efforts by marketing, design, research, engineering and supply chain management that leads to better products for everyone. A holistic view that focuses on both social and environmental responsibility. A passion and a shared point of view.

The right thing to do.

- Meets and/or exceeds EMEA environmental regulatory requirements.
- Eco friendly packaging with a minimum 20% post consumer recycled content.
- Phone housing is built with a minimum of 25% post consumer recycled content plastic.

1.	Getting started .....	6
2.	Getting to know your phone .....	8
3.	Using the phone .....	11
3.1	Calls .....	11
3.1.1	Make a call .....	11
3.1.2	Pre-dial .....	11
3.1.3	End a call .....	11
3.1.4	Receive a call .....	11
3.2	Hold.....	11
3.3	Redial .....	11
4.	Memory .....	12
4.1	Store a memory number .....	12
4.2	Store a memory number from the calls list .....	12
4.3	Store a memory number from the redial list .....	12
4.4	Dial a two-touch memory number .....	12
4.5	Dial a two-touch memory number on hands-free.....	12
4.6	Dial a one-touch memory number .....	12
4.7	Dial a one-touch memory number on hands-free.....	13
5.	Ring tone .....	14
5.1	Set the ringtone .....	14
5.2	Set the ringer volume .....	14
6.	Date and time .....	15
6.1	Set the date and time.....	15
7.	Area Code .....	16
7.1	To store the area code .....	16
8.	PABX access code .....	17
9.	Display .....	18
9.1	Change the display contrast .....	18
10.	Alarm.....	19
11.	Recall and dial mode .....	20
11.1	Change your dial mode.....	20

12. Calls lists .....	21
12.1 Enter the Missed calls list.....	21
12.2 Enter the Received calls list.....	21
12.3 Enter the Redial list .....	21
12.4 Dial a number from the Missed or Received calls list or Redial list.....	21
12.5 Delete a number from the Missed or Received calls list or Redial list .....	21
12.6 Delete all numbers from the Missed or Received calls list or Redial list.....	22
13. Help.....	23
14. General information .....	24

## 1. Getting started

### IMPORTANT

Do not place your CT330 in the bathroom or other humid areas.

### Location

You need to place your CT330 base within 2 metres of the telephone wall socket so that the cable will reach. The socket-outlet shall be installed near the equipment and shall be easily accessible.

### Connecting the handset

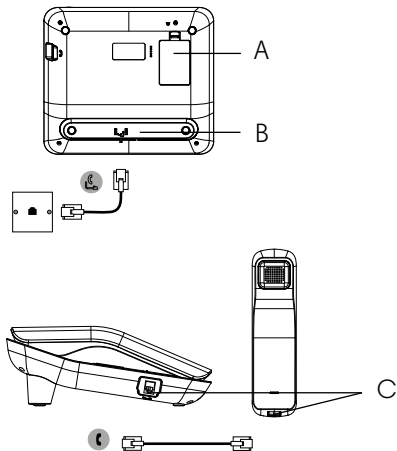

#### A Battery compartment

Fit with 3 x AAA alkaline batteries.

#### B Linecord connection

Plug the line cord into the socket marked  on the underside of the base unit.

#### C Handset connections

Plug the one end of the handset curly cord into the socket on the side of the base marked  and the other into the socket at the bottom of the handset.

### NOTE

Batteries are used for LCD back light. Change the batteries periodically or when the back light becomes dull.

This phone will operate even without installing the batteries.

## Overview of your handset

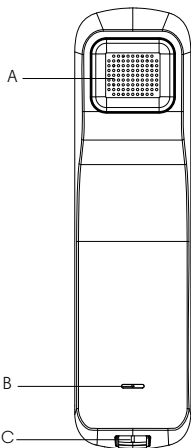

### A Earpiece

To listen to your caller.

### B Microphone

To speak to your caller.

### C Curly cord socket

Where you plug in your curly cord.

## Date and time

If you have subscribed to a FSK type Caller ID Service, the date and time is set automatically when you receive your first call.

If you do not have a FSK Caller ID service, you can set the date and time manually.

### NOTE

*In either case year has to be manually set.*

1. Press **[SET]**, the display shows SET 1 dAtE.
2. Press **[SET]** to select.
3. The year will flash; scroll **▲** or **▼** to the correct year and press **[SET]** to confirm.
4. Repeat this procedure for the month, day and time settings.
5. Press **✕** to exit.

## 2. Getting to know your phone

### Overview of the base

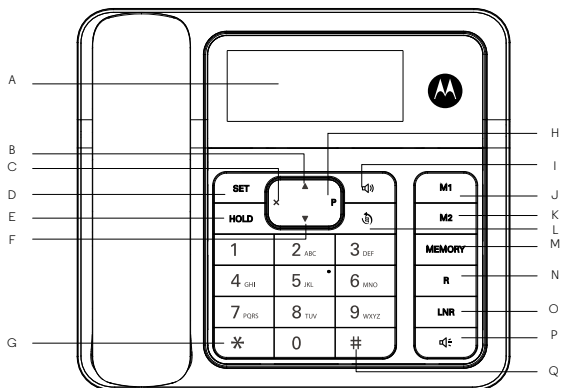

#### A Display

See next section for an overview of display icons.

#### B Received calls list / Scroll up

Press to enter the Received calls list.

Scroll up through ringtones and calls list entries.

#### C Delete / R1 Short recall (100ms)

Press to delete an incorrect number.

To be used with certain network services.

#### D Setting / Store

Enter the settings menu.

Press to store a two touch memory number.

#### E Ring setting / Hold

Press to enter the ringtone setting.

During a call press to put the caller on hold.

#### F Missed calls list / Scroll down

Press to enter the Missed calls list.

Scroll down through ringtones and calls list entries.

#### G \*

Dial a \*.



## **H Pause**

When dialling or storing a number press to enter a pause (P).

## **I Volume up / down**

Press to change the ringer volume in standby mode.

Press to change the hands-free volume.

## **J M1**

Press when storing and dialling memory numbers.

## **K M2**

Press when storing and dialling memory numbers.

## **L Redial call list**

Press to enter the redial list.

## **M Memory**

Press to access the two-touch memory numbers.

## **N R2 Long Recall (600ms) / LCD contrast**

To be used with certain network services.

When on an external call, press to access a Call Waiting Line when a call waiting prompt signal is heard. Press again to toggle between the two calls.

Use to change the contrast of the display.

## **O Redial**

With the handset lifted or on hands-free press to dial the last number dialled.

Press to dial a pre-dialled or calls list number over hands-free.

## **P Hands-free**

Activate and deactivate the hands-free during / when making a call.

## **Q #**

Dial a #.

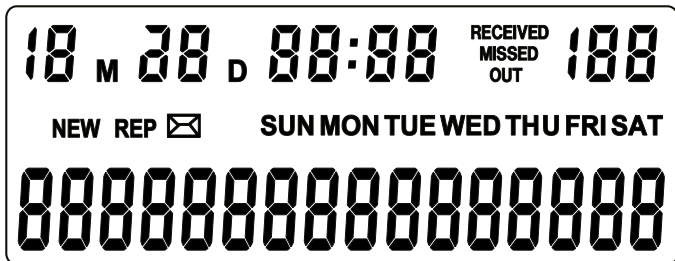

**MISSED** Indicates when you are viewing the missed calls list.<sup>1</sup>

**RECEIVED** Indicates when you are viewing the received calls list.<sup>1</sup>

**OUT** Indicates when you are viewing the redial list.

**NEW** Flashes when you have received a new call.

**REP** Indicates when you have more than 1 missed call from the viewed number.

 Indicates when you have a voicemail waiting.<sup>2</sup>

<sup>1</sup>For this feature to work, you must subscribe to Caller ID Service from your network operator. A subscription fee may be payable.

<sup>2</sup>This feature is dependent on your Network Service provider supporting the service.



## 3. Using the phone

### 3.1 Calls

#### 3.1.1 Make a call

Lift the handset, when you hear the dial tone, dial the number.

#### 3.1.2 Pre-dial

1. Enter the phone number (maximum 32 digits). If you make a mistake press **X**.
2. Press  or  to dial the phone number entered over hands-free.
3. Lift the handset to talk on the handset.

#### 3.1.3 End a call



1. Place the handset back on the base.
2. Or press the  to end a hands-free call.

#### 3.1.4 Receive a call

1. Lift the handset or press  to answer the call.



### NOTE

You can adjust the volume between high and low; during the call simply press the  to change the setting.

If during a call you want to activate hands-free, press  and hang up the handset. To return to the listening via the earpiece, simply lift the handset. You can adjust the volume of a hands-free during the call, press , there are 2 levels to choose from.

### 3.2 Hold

You can place your caller on hold so that you and your caller hear hold music.

1. During a call, press the  button and you and your caller will hear hold music.
2. Press  again to resume your call.

### NOTE



The hold feature will NOT mute the microphone.

If you are using the handset and place a caller on hold you can place the handset on the base and the call remains on hold, when you lift the handset again the call will resume automatically.



### 3.3 Redial

The last entry dialled is stored in the phone; this can be up to 32 digits long.



#### To redial the last entry dialled:

1. Pick up the handset and press the  button.
2. Or press  and then press the  to dial the phone number entered over hands-free.







## 4. Memory

You can store 10 two-touch memory numbers and 2 one touch memory numbers under the  and  buttons; the numbers can be up to 16 digits long.





### 4.1 Store a memory number

1. Dial the number to be stored.
2. Press .
3. Press one of the numbers on the keypad 0-9,  or  the number is stored.

### 4.2 Store a memory number from the calls list

1. Press  or  to enter missed or received calls list.
2. Scroll  or  to required number.
3. Press .
4. Press one of the numbers on the keypad 0-9,  or  the number is stored.

### 4.3 Store a memory number from the redial list

1. Press  to enter redial list.
2. Keep pressing  to scroll through the list.
3. Press .
4. Press one of the numbers on the keypad 0-9,  or  the number is stored.



### 4.4 Dial a two-touch memory number

1. Lift the handset.
2. Press .
3. Press one of the keypad buttons 0-9.
4. The memory number will be dialled out.



### 4.5 Dial a two-touch memory number on hands-free

1. Press .
2. Press one of the keypad buttons 0-9.
3. The memory number will be dialled out.

### 4.6 Dial a one-touch memory number

1. Lift the handset.
2. Press  or .
3. The memory number will be dialled out.

## 4.7 Dial a one-touch memory number on hands-free

1. Press  or .
2. The memory number will be dialled out.

### **NOTE**





*Remember to make a note of your memory numbers for easy reference.*

*To change the phone number in the memory just overwrite the new number in the same location.*



## 5. Ring tone

Your CT330 has a choice of 24 ringtones and choose from 4 volume levels and crescendo.

### 5.1 Set the ringtone

1. Press . The current ringtone is played.
2. Press  or  to scroll to the required ringtone. A sample of the ringtone is played.
3. Press  to confirm and return to standby.

### 5.2 Set the ringer volume

1. When the handset is on the base press , the display shows VOL and the current volume 1 - 4 or CrESC if crescendo is selected.
2. Keep pressing  to select the required volume.

#### **NOTE**

*The ringer volume cannot be set to OFF.*

## 6. Date and time



If you have subscribed to a FSK type Caller ID Service, the date and time is set automatically when you receive your first call.

If you do not have a FSK Caller ID service, you can set the date and time manually.

### NOTE

*In either case year has to be manually set.*



### 6.1 Set the date and time

1. Press , the display shows SET 1 dAtE.
2. Press  to select.
3. The year will flash; scroll ▲ or ▼ to the correct year and press  to confirm.
4. Repeat this procedure for the month, day and time settings.
5. Press **X** to exit.

## 7. Area Code

You can set your local area code into the phone. When a number from that area code calls only the local number will be displayed and stored.

### 7.1 To store the area code

1. Press , the display shows SET 1 dAtE.
2. Scroll ▲ or ▼ to SET 2 C0dE.
3. Press , the display shows C0dE - - - -.
4. The first - is flashing, press ▲ or ▼ to scroll to the correct digit.
5. Press  to confirm.
6. Repeat this procedure until the full code is entered.

#### **NOTE**



*This setting is not required in Singapore as there is no Area Code.*



## 8. PABX access code

If the CT330 is connected to a switchboard, you may need to enter a one-digit access code in the dialling sequence to be able to connect to the outside line.

The access code will be displayed at the beginning of a number on the screen.



1. Press , the display shows SEt 1 dAtE.
2. Scroll ▲ or ▼ to SEt 3 PC0dE.
3. Press , the display shows PC0dE -.
4. Press ▲ or ▼ to scroll to the correct digit from 0 - 9.
5. Press  to confirm.

## 9. Display



You can change the contrast of the display; there are 5 levels to choose from.

### 9.1 Change the display contrast

Either:



1. Press , the display shows SEt 1 dAtE.
2. Scroll ▲ or ▼ to SEt 4 LCd.
1. Press , the display shows LCd and the current contrast level.
2. Scroll ▲ or ▼ until you see the contrast you require.
3. Press  to confirm.

Or:

1. Press , the display shows LCd and the current contrast level (1-5).
2. Continue pressing  until you see the contrast you require.
3. Press **X** to exit.

## 10. Alarm

Your CT330 has an alarm that once set will go off every day unless turned off.

1. Press , the display shows SET 1 dAtE.
2. Scroll ▲ or ▼ to SET 5 ALERt.
3. Press  and the display shows 00-00 OFF.
4. Scroll ▲ or ▼ to set the first digit and  to confirm.
5. Repeat this procedure until all digits are correct.
6. Scroll ▲ or ▼ to On.
7. Press **X** to exit.

### NOTE

*To stop the alarm press any key or lift the handset. The alarm will stop automatically after 1 minute if no button is pressed. If at the alarm time the phone is ringing, the handset is lifted or the phone is in use the alarm will be cancelled.*

## 11. Recall and dial mode

Recall is useful to access certain network services and PABX /switchboard services. Your CT330 has 2 recall buttons, **X** is the short flash time and **\*** is for long flash time.

### NOTE

**X** Short flash is 100ms / **\*** Long Flash is 600ms.

Flash keys are used to refresh a dial tone. When on an external call, press **\*** to access a Call Waiting Line when a call waiting prompt signal is heard. Press again to toggle between the two calls.

For more information about network services contact your network operator.

Your phone is set to tone dialling. You should only need to change this if connected to an older type of switchboard / PABX which requires pulse dialling.

### 11.1 Change your dial mode

1. Press **SET**, the display shows SET 1 dAtE.
2. Scroll **▲** or **▼** to SEt 6 P\_t.
3. Press **SET** and the display shows the current setting.
4. Scroll **▲** or **▼** to the change the setting.
5. Press **X** to exit.

## 12. Calls lists

If you have subscribed to a Caller ID service, and provided the identity of the caller is not withheld, the number of the caller will be displayed together with the date and time of the call (if provided by the network). When the list is full and a new call is received, the oldest non VIP entry will be deleted automatically.

You can store up to 34 numbers between the missed and received calls lists and each number can be up to 16 digits long.

### Note

*If you receive a private call --P-- will show on the display.*

*If you receive an out of area call --O-- will show on the display.*

*If you receive an error call --E-- will show on the display.*

### 12.1 Enter the Missed calls list



1. Press ▼ to enter the Missed calls list.
2. Press the ▲ or ▼ to scroll through the numbers.
3. If no numbers are stored the screen will display --End--.

### 12.2 Enter the Received calls list



1. Press ▲ to enter the Received calls list.
2. Press the ▲ or ▼ to scroll through the numbers.
3. If no numbers are stored the screen will display --End--.

### 12.3 Enter the Redial list

The last 10 entries dialled are stored in the phone; these can be up to 16 digits long.

1. Press  to enter the Redial list.
2. Keep pressing  to scroll through the list.
3. If no numbers are stored the screen will display --End--.

### 12.4 Dial a number from the Missed or Received calls list or Redial list

1. Press ▼ to enter the Missed calls list, ▲ to enter the Received calls list or  to enter the Redial list.
2. Scroll to the number you want to dial and either lift the handset or press  /  to dial over the loudspeaker.

### 12.5 Delete a number from the Missed or Received calls list or Redial list

1. Press ▼ to enter the Missed calls list, ▲ to enter the Received calls list or  to enter the Redial list.
2. Scroll to the number you want to delete and press ✕.
3. The number is deleted.

## 12.6 Delete all numbers from the Missed or Received calls list or Redial list

1. Press ▼ to enter the Missed calls list, ▲ to enter the Received calls list or  to enter the Redial list.
2. Press and hold ✕ for 3 seconds.
3. All the numbers are deleted.

## 13. Help

### No dial tone

- Use only the telephone line cord supplied.
- Check that the telephone line cord is connected properly.

### Storing numbers

- Once you have stored a number there is no confirmation tone.
- A number cannot be deleted once stored, you can overwrite it with a new number.

## 14. General information

### **IMPORTANT**

*This product is intended for connection to analogue public switched telephone networks and private switchboards within Singapore*

### **Important safety instructions**

Follow these safety precautions when using your phone to reduce the risk of fire, electric shock, and injury to persons or property:

- Do not set the phone on a heating register or over a radiator. Ensure that proper ventilation is provided at the installation site.
- Do not use while wet or while standing in water.
- Do not use this product near water (for example, near a bath tub, kitchen sink, or swimming pool).
- Do not disassemble this product. If service or repair work is required, contact the customer service helpline found in this User's Guide.
- Avoid using during an electrical storm. Use a surge protector to protect the equipment.

### **Installation Guidelines**

- Read and understand all instructions and save them for future reference.
- Follow all warnings and instructions marked on the product.
- Do not install this product near a bath tub, sink, or shower.
- Do not place this product on an unstable cart, stand, or table. This product may fall, causing serious damage to the product.
- Adjust only those controls that are covered by the operating instructions. Improper adjustment of other controls may result in damage and will often require extensive work to restore the product to normal operation.

### **Cleaning**

- Clean the handset and base with a damp (not wet) cloth, or an anti-static wipe.
- Never use household polish as this will damage the product. Never use a dry cloth as this may cause static shock.

### **Environmental**

- Do not expose to direct sunlight.
- Do not place your product on carpets or other surfaces which generate fibres, or place it in locations preventing the free flow of air over its surfaces.
- Do not submerge any part of your product in water and do not use it in damp or humid conditions, such as bathrooms.
- Do not expose your product to fire, explosives or other hazardous conditions.



- There is a slight chance that your phone could be damaged by an electrical storm. We recommend that you unplug the telephone line cord during an electrical storm.

## Product disposal instructions

### *Product disposal instructions for residential users*

When you have no further use for it, please dispose the product according to your local authority's recycling processes. For more information, please contact your local authority or the Retailer where the product was purchased.

### *Product disposal instructions for business users*

Business users should contact their suppliers and check the terms and conditions of the purchase contract and ensure that this product is not mixed with other commercial waste for disposal.

## Consumer Products and Accessories Warranty

Thank you for purchasing this Motorola branded product manufactured under license by Suncorp Technologies Limited, 3001-3005 China Resources Building, 26 Harbour Road, Wan Chai, Hong Kong. ("SUNCORP")

### *What Does this Warranty Cover?*

Subject to the exclusions contained below, SUNCORP warrants that this Motorola branded product ("Product") or certified accessory ("Accessory") sold for use with this product that it manufactured to be free from defects in materials and workmanship under normal consumer usage for the period outlined below. This Limited Warranty is your exclusive warranty and is not transferable.

### *Who is covered?*

This warranty extends only to the first consumer purchaser, and is not transferable.

### *What will SUNCORP do?*

SUNCORP or its authorized distributor at its option and within a commercially reasonable time, will at no charge repair or replace any Products or Accessories that do not conform to this limited warranty. We may use functionally equivalent reconditioned / refurbished / pre-owned or new Products, Accessories or parts.

### *What Other Limitations Are There?*

ANY IMPLIED WARRANTIES, INCLUDING WITHOUT LIMITATION THE IMPLIED WARRANTIES OF MERCHANTABILITY AND FITNESS FOR A PARTICULAR PURPOSE, SHALL BE LIMITED TO THE DURATION OF THIS LIMITED WARRANTY, OTHERWISE THE REPAIR OR REPLACEMENT PROVIDED UNDER THIS EXPRESS LIMITED WARRANTY IS THE EXCLUSIVE REMEDY OF THE CONSUMER, AND IS PROVIDED IN LIEU OF ALL OTHER WARRANTIES, EXPRESS OF IMPLIED. IN NO EVENT SHALL MOTOROLA OR SUNCORP BE LIABLE, WHETHER IN CONTRACT OR TORT (INCLUDING NEGLIGENCE) FOR DAMAGES IN EXCESS OF THE PURCHASE PRICE OF THE PRODUCT OR ACCESSORY, OR FOR ANY INDIRECT, INCIDENTAL, SPECIAL OR CONSEQUENTIAL DAMAGES OF ANY KIND, OR LOSS OF INFORMATION OR OTHER FINANCIAL LOSS ARISING OUT OF OR IN CONNECTION WITH THE ABILITY OR INABILITY TO USE THE PRODUCTS OR ACCESSORIES TO THE FULL EXTENT

## THESE DAMAGES MAY BE DISCLAIMED BY LAW.

Some jurisdictions do not allow the limitation or exclusion of incidental or consequential damages, or limitation on the length of an implied warranty, so the above limitations or exclusions may not apply to you. This warranty gives you specific legal rights, and you may also have other rights that vary from one jurisdiction to another.

Products Covered	Length of Coverage
Consumer Products	<b>One (1) year</b> from the date of the products original purchase by the first consumer purchaser of the product.
Consumer Accessories (battery, power supply(s) and line cords)	<b>Ninety (90) days</b> from the date of the accessories original purchase by the first consumer purchaser of the product.
Consumer Products and Accessories that are Repaired or Replaced	<b>The balance of the original warranty or for ninety (90) days</b> from the date returned to the consumer, whichever is longer.

## Exclusions

**Normal Wear and Tear.** Periodic maintenance, repair and replacement of parts due to normal wear and tear are excluded from coverage.

**Abuse & Misuse.** Defects or damage that result from: (a) improper operation, storage, misuse or abuse, accident or neglect, such as physical damage (cracks, scratches, etc.) to the surface of the product resulting from misuse; (b) contact with liquid, water, rain, extreme humidity or heavy perspiration, sand, dirt or the like, extreme heat, or food; (c) use of the Products or Accessories for commercial purposes or subjecting the Product or Accessory to abnormal usage or conditions; or (d) other acts which are not the fault of Motorola or SUNCORP, are excluded from coverage.

**Use of Non-Motorola branded Products and Accessories.** Defects or damage that result from the use of Non-Motorola branded or certified Products or Accessories or other peripheral equipment are excluded from coverage.

**Unauthorized Service or Modification.** Defects or damages resulting from service, testing, adjustment, installation, maintenance, alteration, or modification in any way by someone other than Motorola, SUNCORP or its authorized service centers, are excluded from coverage.

**Altered Products.** Products or Accessories with (a) serial numbers or date tags that have been removed, altered or obliterated; (b) broken seals or that show evidence of tampering; (c) mismatched board serial numbers; or (d) nonconforming or non-Motorola branded housings, or parts, are excluded from coverage.

**Communication Services.** Defects, damages, or the failure of Products or Accessories due to any communication service or signal you may subscribe to or use with the Products or Accessories is excluded from coverage.

### ***How to Obtain Warranty Service or Other Information?***

To obtain service or information, please call: (65) 68412668.

Email: support@alcom.com.sg

You will receive instructions on how to ship the Products or Accessories at your expense and risk, to a SUNCORP Authorized Repair Center.

To obtain service, you must include: (a) the Product or Accessory; (b) the original proof of purchase (receipt) which includes the date, place and seller of the Product; (c) if a warranty card was included in your box, a completed warranty card showing the serial number of the Product; (d) a written description of the problem; and, most importantly; (e) your address and telephone number.

### **Connecting to a switchboard**

This product is intended for use within Singapore for connection to the public telephone network.

### **Recall**

You may need to use the recall function if you are connected to a switchboard. Contact your PABX supplier for further information.

<This page has been intentionally left blank>

## Declaration of Conformity (DoC)

Suncorp declares that the following products:

Brandname: Motorola  
Type: CT330  
Descriptions: Corded telephone

to which this declaration related is in conformity with the essential requirements of the following directives of the Council of the European Communities:

- Low voltage Directive (2006/95/EC)
- EMC Directive (2004/108/EC)
- R&TTE Directive (1999/5/EC)

The products are compliant with the following standards:

Safety: EN60950-1: 2006+A11:2009+A1:2010+A12:2011+A2:2013  
EMC: EN55022:2010  
EN55024:2010

For and on behalf of Suncorp Technologies Limited,

Signature:



Printed name & Position: CW Cheung – Chief Technical Officer

Date: March 31, 2015

Place: 2/F, Shui On Centre, 6-8 Harbour Road, Hong Kong

Manufactured, distributed or sold by Suncorp Technologies Ltd., official licensee for this product. MOTOROLA and the Stylized M Logo are trademarks or registered trademarks of Motorola Trademark Holdings, LLC. and are used under license. All other trademarks are the property of their respective owners. © 2015 Motorola Mobility LLC. All rights reserved.

Version 5 (SG)

