



motorola

Corded Telephone



Model: CT2



# Welcome...

## *to your new Motorola CT2 Corded Telephone!*

- Recall for network functions.
- Hold facility to put your caller on hold and listen to music.
- Redial the last number dialled at the touch of a button.
- Repeat call symbol to alert you if you missed a call from the same number more than once.
- Redial at least 5 dialled numbers for easy dialling.
- 10 two-touch memory numbers for easy dialling.
- Tone and Pulse dialling.
- Ringer and hands-free volume control.
- Speakerphone for hands-free conversations.
- Time and date function.
- Caller ID shows you the number of who is calling and stores the number of at least the last 32 callers in a Calls list.<sup>1</sup>
- Call Timer the display will automatically time the duration of all external calls.

Your CT2 uses dynamic software in the redial and received calls list, if the phone numbers in the list have less than 16 digits then the number of entries stored in the received calls list is increased.

### **Need help?**

If you have any problems setting up or using your CT2, please contact Customer Services on (65) 68412668.  
Email: [support@alcom.com.sg](mailto:support@alcom.com.sg)

Alternatively, you may find the answer in the 'Help' section at the back of this guide.

<sup>1</sup>You must subscribe to your network provider's Caller ID or Call Waiting service for these features to work. A subscription fee may be payable.

**This user guide provides you with all the information you need to get the most from your phone.**

**To set up your phone, follow the simple instructions in 'Getting Started', on the next few pages.**

## **IMPORTANT**

Only use the telephone line cord supplied.

### **Got everything?**

- Corded handset and curly cord
- Corded base
- Telephone line cord



ECOMOTO: a convergence of efforts by marketing, design, research, engineering and supply chain management that leads to better products for everyone. A holistic view that focuses on both social and environmental responsibility. A passion and a shared point of view.

The right thing to do.

- Meets and/or exceeds EMEA environmental regulatory requirements.
- Eco friendly packaging with a minimum 20% post consumer recycled content.
- Phone housing is built with a minimum of 25% post consumer recycled content plastic.

1.	Getting started .....	6
2.	Getting to know your phone .....	8
3.	Using the phone .....	11
3.1	Calls .....	11
3.1.1	Make a call .....	11
3.1.2	Pre-dial .....	11
3.1.3	End a call .....	11
3.1.4	Receive a call .....	11
3.2	Hold.....	11
3.3	Redial .....	12
3.4	Open the Redial list .....	12
3.5	Dial a number from the Redial list .....	12
4.	Memory .....	13
4.1	Store a two-touch memory number .....	13
4.2	Store a two-touch memory number from the calls list.....	13
4.3	Dial a two-touch memory number with the handset lifted .....	13
4.4	Dial a two-touch memory number over the loudspeaker.....	13
4.5	Check and delete a memory number .....	13
5.	Date and time .....	14
5.1	Set the date and time.....	14
6.	Area Code .....	15
6.1	Store the area code .....	15
7.	PABX access code .....	16
7.1	Store the PABX access code.....	16
8.	Display .....	17
8.1	Change the display contrast .....	17
9.	Recall and dial mode .....	18
9.1	Change your dial mode.....	18
10.	Calls lists .....	19
10.1	Open the Received calls list .....	19
10.2	Dial a number from the Received calls list .....	19
10.3	Open the Missed calls list .....	19
10.4	Dial a number from the Missed calls list .....	19



11. Help.....	20
12. General information .....	21
13. Wall mounting .....	25

## 1. Getting started

### IMPORTANT

Do not place your CT2 in the bathroom or other humid areas.



### Location

You need to place your CT2 base within 2 metres of the telephone wall socket so that the cable will reach. The socket-outlet shall be installed near the equipment and shall be easily accessible.

If you are wall mounting your phone please refer to the wall mount template on page 25.

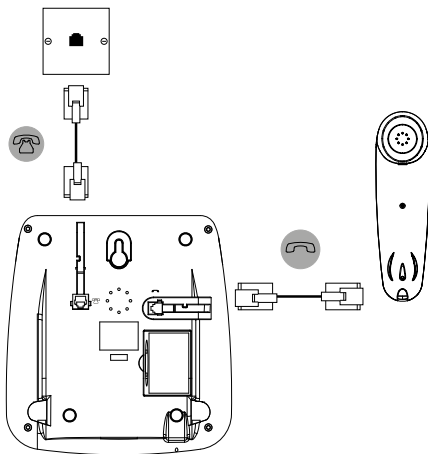
### Connecting the handset and base



1. Plug one end of the handset curly cord into the socket marked  on the underside of the base and the other end into the socket at the bottom of the handset.
2. Plug the telephone line cord into the socket marked .

## Overview of your handset

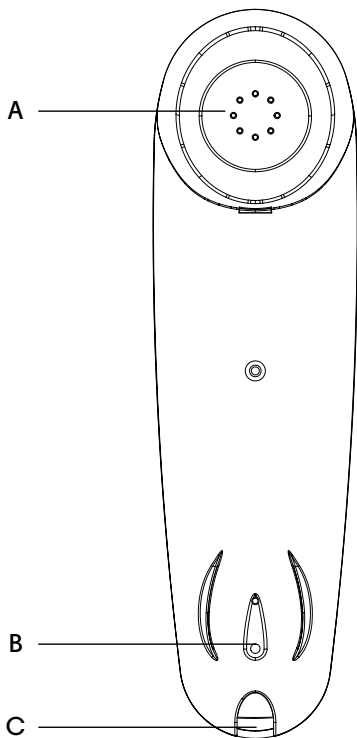

**A Earpiece**

To listen to your caller.

**B Microphone**

To speak to your caller.

**C Curly cord socket**

Where you plug in your curly cord.

## 2. Getting to know your phone

### Overview of the base

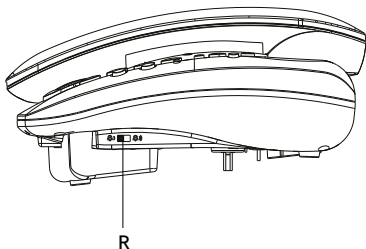
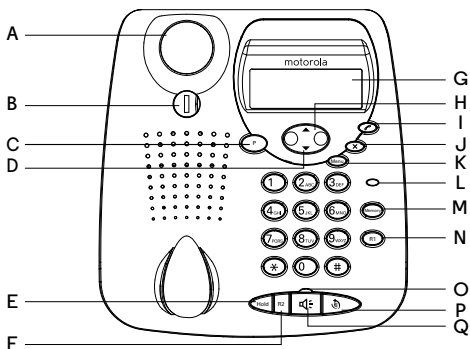

**A Hook switch**

Hangs up a call when pressed or when you replace the handset.

**B Handset hook**

Rotate to secure the handset in wall mount mode.

**C Pause**

When dialling or storing a number press to enter a pause (P).



**D Down**

Press to scroll down through the menu.  
In standby mode press to open the missed calls list.

**E Hold**

Press to put your caller on hold.

**F R2 Long Recall (600ms)**

To be used with certain network services.  
When on an external call, press to access a Call Waiting Line when a call waiting prompt signal is heard. Press again to toggle between the two calls.

**G Display**

See page 10 for an overview of display icons.

**H Up**

Press to scroll up through the menu.  
In standby mode press to open the calls list.

**I Redial**

Press to view last number dialled out and continue pressing to scroll through the 5 stored numbers.

**J Delete**

Press to delete an incorrect number or go back in the menu.

**K Menu**

Press to open the menu or confirm a menu option.

**L New missed call indicator / Ring indicator**

Flashes when you have new missed calls and when the phone is ringing.

**M Memory**

Dial out two-touch memory numbers.

**N R1 Short Recall (100ms)**

To be used with certain network services.

**O Ring indicator**

Flashes to indicate the phone is ringing.

**P Last number redial**

Press to redial the last number dialled.

**Q Hands-free**

Activate and deactivate the hands-free during / when making a call.

**R Ringer switch**

Switch the ringer volume from high (🔊) to low (🔇).

**NOTE**

*The ringer volume cannot be set to OFF.*

## Display

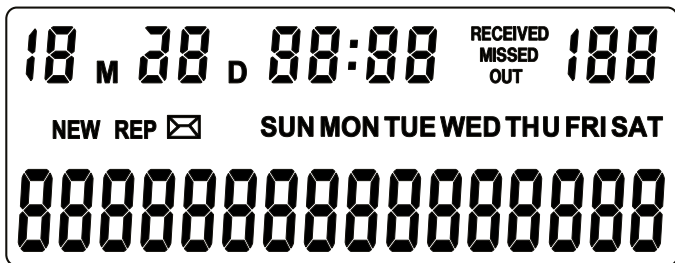

**MISSED** Indicates when you are viewing the missed calls list.<sup>1</sup>

**RECEIVED** Indicates when you are viewing the received calls list.<sup>1</sup>

**OUT** Indicates when you are viewing the redial list.

**NEW** Flashes when you have received a new call.

**REP** Indicates when you have more than 1 missed call from the viewed number.

 Indicates when you have a voicemail waiting.<sup>2</sup>

<sup>1</sup>For this feature to work, you must subscribe to Caller ID Service from your network operator. A subscription fee may be payable.

<sup>2</sup>This feature is dependent on your Network Service provider supporting the service.



### 3. Using the phone

#### 3.1 Calls

##### 3.1.1 Make a call

Lift the handset, when you hear the dial tone, dial the number.

##### 3.1.2 Pre-dial

1. Enter the phone number (maximum 32 digits). If you make a mistake press . Lift the handset to dial the number.
2. Press  to dial the phone number over hands-free.

#### NOTE

You can also make calls using the two touch memory keys, see page 13.

##### 3.1.3 End a call



1. Place the handset back on the base.
- Or:
2. Press  to end a hands-free call.

##### 3.1.4 Receive a call

1. Lift the handset to answer the call.
- Or:
2. Press  to answer the call in hands-free.



#### NOTE

If during a call you want to activate hands-free, press  and hang up the handset.

To change the ringer volume from high () to low () use the switch on the side of the base.

#### 3.2 Hold

You can place your caller on hold so that you and your caller hear hold music.

1. During a call, press  and you and your caller will hear hold music.
2. Press  again to resume your call.

#### NOTE



If  is pressed when not on a call a beep will be heard, but it will have no effect on the functions of the phone.

### 3.3 Redial

The last number dialled is stored in the phone; this can be up to 32 digits long.

1. Pick up the handset and press .

Or:



2. Press  and then .

### 3.4 Open the Redial list

The last 5 entries dialled are stored in the phone; these can be up to 16 digits long.

1. Press  to open the Redial list.
2. Continue pressing to scroll through the list.

### 3.5 Dial a number from the Redial list

1. Press  to open the Redial list.
2. Continue pressing  to scroll to the entry you want.
3. Lift the handset or press  to dial the displayed entry.





## 4. Memory

You can store ten telephone numbers in the two touch memory; the numbers can be up to 16 digits long.

### 4.1 Store a two-touch memory number

1. Dial the number to be stored.
2. Press .
3. Press one of the numbers on the keypad 0-9, the number is stored.

### 4.2 Store a two-touch memory number from the calls list

1. Press  to open the received or  to open the missed calls list.
2. Scroll  or  to required number.
3. Press .
4. Press one of the numbers on the keypad 0-9.



### 4.3 Dial a two-touch memory number with the handset lifted

1. Lift the handset.
2. Press .
3. Press one of the keypad buttons 0-9.
4. The memory number will be dialled.

### 4.4 Dial a two-touch memory number over the hands-free

1. Press .
2. Press one of the keypad buttons 0-9.
3. The memory number will dial out automatically.

### 4.5 Check and delete a memory number

1. Press .
2. Press and hold the relevant keypad number 0 - 9 for 3 seconds.
3. The memory number will be displayed.
4. Press  to delete the memory number.

#### NOTE

*Remember to make a note of your memory numbers for easy reference.*

## 5. Date and time

If you have subscribed to a FSK type Caller ID Service, the date and time is set automatically when you receive your first call.

If you do not have a FSK Caller ID service, you can set the date and time manually.

### 5.1 Set the date and time

1. Press **Menu**, the display shows SET 1 dAtE.
2. Press **Menu** to select.
3. The year will flash; scroll ▲ or ▼ to the correct year and press **Menu** to confirm.
4. Repeat this procedure for the month, day and time settings.
5. Press **X** to exit.

## 6. Area Code

You can set your local area code into the phone. When a number from that area code calls only the local number will be displayed and stored.

### 6.1 Store the area code







1. Press **Menu**, the display shows SEt 1 dAtE.
2. Scroll **▲** or **▼** to SEt 2 CodE.
3. Press **Menu**, the display shows CodE - - - -.
4. The first - is flashing, press **▲** or **▼** to scroll to the correct digit.
5. Press **Menu** to confirm.
6. Repeat this procedure until the full code is entered.

## 7. PABX access code

If the CT2 is connected to a switchboard, you may need to enter a one-digit access code in the dialling sequence to be able to connect to the outside line.

The access code will be displayed at the beginning of a number on the screen.

### 7.1 Store the PABX access code

1. Press , the display shows SET 1 dAtE.
2. Scroll  or  to SET 3 PCOdE.
3. Press , the display shows PCOdE -.
4. Press  or  to scroll to the correct digit from 0 - 9.
5. Press  to confirm.



## 8. Display

You can change the contrast of the display; there are 5 levels to choose from.

### 8.1 Change the display contrast

Either:

1. Press **Menu**, the display shows SEt 1 dAtE.
2. Scroll **▲** or **▼** to SEt 4 lCd.
1. Press **Menu**, the display shows LCd and the current contrast level.
2. Scroll **▲** or **▼** until you see the contrast you require.
3. Press **Menu** to confirm.

Or:

1. Press **R2**, the display shows LCd and the current contrast level (1-5).
2. Continue pressing **R2** until you see the contrast you require.
3. Press **X** to exit.

## 9. Recall and dial mode

Recall is useful to access certain network services and PABX /switchboard services. Your CT2 has 2 recall buttons (R1) is the short flash time and (R2) is for long flash time.

### NOTE

(R1) Short flash is 100ms / (R2) Long Flash is 600ms.

Flash keys are used to refresh a dial tone. When on an external call, press R2 to access a Call Waiting Line when a call waiting prompt signal is heard. Press again to toggle between the two calls.

For more information about network services contact your network operator.

Your phone is set to tone dialling. You should only need to change this if connected to an older type of switchboard / PABX which requires pulse dialling.

### 9.1 Change your dial mode

1. Press (Menu), the display shows SEt 1 dAtE.
2. Scroll ▲ or ▼ to SEt 5 P\_t.
3. Press (Menu) and the display shows the current setting.
4. Scroll ▲ or ▼ to the change the setting.
5. Press (X) to exit.

## 10. Calls lists

If you have subscribed to a Caller ID service, and provided the identity of the caller is not withheld, the number of the caller will be displayed together with the date and time of the call (if provided by the network). When the list is full and a new call is received, the oldest entry will be deleted automatically.

You can store at least 32 numbers in the received calls list and each number can be up to 16 digits long.



### NOTE

*If you receive a private call --P-- will show on the display.*



*If you receive an out of area call --O-- will show on the display.*

*If you receive an error call --E-- will show on the display.*



### 10.1 Open the Received calls list

1. Press  to open the Received calls list.
2. Continue pressing  to scroll through the list.
3. The display will show --End-- when you reach the end of the list.



### 10.2 Dial a number from the Received calls list

1. Press  to open the Received calls list.
2. Continue pressing  to scroll to the number you want to dial.
3. Either lift the handset to dial automatically, or press  to dial over hands-free.

### 10.3 Open the Missed calls list

1. Press  to open the Missed calls list.
2. Continue pressing  to scroll through the list.
3. The display will show --End-- when you reach the end of the list.

### 10.4 Dial a number from the Missed calls list

1. Press  to open the Missed calls list.
2. Continue pressing  to scroll to the number you want to dial.
3. Either lift the handset to dial automatically, or press  to dial over hands-free.

### NOTE

*If you have missed calls the LED on the base will flash.*

*If you have more than one missed call from the same number **REP**, will show on the display when you view the missed calls list.*

## 11. Help

### No dial tone

- Use only the telephone line cord supplied.
- Check that the telephone line cord is connected properly.

### Storing numbers

- Once you have stored a number there is no confirmation tone, you can just hang up the handset.
- Please remember to make a note of memory numbers for easy reference.

## 12. General information

### **IMPORTANT**

*This product is intended for connection to analogue public switched telephone networks and private switchboards in Singapore.*

### **Important safety instructions**

Follow these safety precautions when using your phone to reduce the risk of fire, electric shock, and injury to persons or property:

- Do not set the phone on a heating register or over a radiator. Ensure that proper ventilation is provided at the installation site.
- Do not use while wet or while standing in water.
- Do not use this product near water (for example, near a bath tub, kitchen sink, or swimming pool).
- Do not disassemble this product. If service or repair work is required, contact the customer service helpline found in this User Guide.
- Avoid using during an electrical storm. Use a surge protector to protect the equipment.

### **Installation Guidelines**

- Read and understand all instructions and save them for future reference.
- Follow all warnings and instructions marked on the product.
- Do not install this product near a bath tub, sink, or shower.
- Do not place this product on an unstable cart, stand, or table. This product may fall, causing serious damage to the product.
- Adjust only those controls that are covered by the operating instructions. Improper adjustment of other controls may result in damage and will often require extensive work to restore the product to normal operation.

### **Cleaning**

- Clean the handset and base with a damp (not wet) cloth, or an anti-static wipe.
- Never use household polish as this will damage the product. Never use a dry cloth as this may cause static shock.

### **Environmental**

- Do not expose to direct sunlight.
- Do not place your product on carpets or other surfaces which generate fibres, or place it in locations preventing the free flow of air over its surfaces.
- Do not submerge any part of your product in water and do not use it in damp or humid conditions, such as bathrooms.
- Do not expose your product to fire, explosives or other hazardous conditions.

- There is a slight chance that your phone could be damaged by an electrical storm. We recommend that you unplug the telephone line cord during an electrical storm.

## Product disposal instructions

### *Product disposal instructions for residential users*

When you have no further use for it, please dispose the product according to your local authority's recycling processes. For more information, please contact your local authority or the Retailer where the product was purchased.

### *Product disposal instructions for business users*

Business users should contact their suppliers and check the terms and conditions of the purchase contract and ensure that this product is not mixed with other commercial waste for disposal.

## Consumer Products and Accessories Warranty

Thank you for purchasing this Motorola branded product manufactured under license by Suncorp Technologies Limited, 2/F, Shui On Centre, 6-8 Harbour Road, Hong Kong. ("SUNCORP")

### *What Does this Warranty Cover?*

Subject to the exclusions contained below, SUNCORP warrants that this Motorola branded product ("Product") or certified accessory ("Accessory") sold for use with this product that it manufactured to be free from defects in materials and workmanship under normal consumer usage for the period outlined below. This Limited Warranty is your exclusive warranty and is not transferable.

### *Who is covered?*

This warranty extends only to the first consumer purchaser, and is not transferable.

### *What will SUNCORP do?*

SUNCORP or its authorized distributor at its option and within a commercially reasonable time, will at no charge repair or replace any Products or Accessories that do not conform to this limited warranty. We may use functionally equivalent reconditioned / refurbished / pre-owned or new Products, Accessories or parts.

### *What Other Limitations Are There?*

ANY IMPLIED WARRANTIES, INCLUDING WITHOUT LIMITATION THE IMPLIED WARRANTIES OF MERCHANTABILITY AND FITNESS FOR A PARTICULAR PURPOSE, SHALL BE LIMITED TO THE DURATION OF THIS LIMITED WARRANTY, OTHERWISE THE REPAIR OR REPLACEMENT PROVIDED UNDER THIS EXPRESS LIMITED WARRANTY IS THE EXCLUSIVE REMEDY OF THE CONSUMER, AND IS PROVIDED IN LIEU OF ALL OTHER WARRANTIES, EXPRESS OF IMPLIED. IN NO EVENT SHALL MOTOROLA OR SUNCORP BE LIABLE, WHETHER IN CONTRACT OR TORT (INCLUDING NEGLIGENCE) FOR DAMAGES IN EXCESS OF THE PURCHASE PRICE OF THE PRODUCT OR ACCESSORY, OR FOR ANY INDIRECT, INCIDENTAL, SPECIAL OR CONSEQUENTIAL DAMAGES OF ANY KIND, OR LOSS OF INFORMATION OR OTHER FINANCIAL LOSS ARISING OUT OF OR IN CONNECTION WITH THE ABILITY OR INABILITY TO USE THE PRODUCTS OR ACCESSORIES TO THE FULL EXTENT THESE DAMAGES MAY BE DISCLAIMED BY LAW.

Some jurisdictions do not allow the limitation or exclusion of incidental or consequential damages, or limitation on the length of an implied warranty, so the above limitations or exclusions may not apply to you. This warranty gives you specific legal rights, and you may also have other rights that vary from one jurisdiction to another.

Products Covered	Length of Coverage
<b>Consumer Products</b>	<b>One (1) year</b> from the date of the products original purchase by the first consumer purchaser of the product.
<b>Consumer Accessories (line cord)</b>	<b>Ninety (90) days</b> from the date of the accessories original purchase by the first consumer purchaser of the product.
<b>Consumer Products and Accessories that are Repaired or Replaced</b>	<b>The balance of the original warranty or for ninety (90) days</b> from the date returned to the consumer, whichever is longer.

## Exclusions

**Normal Wear and Tear.** Periodic maintenance, repair and replacement of parts due to normal wear and tear are excluded from coverage.

**Abuse & Misuse.** Defects or damage that result from: (a) improper operation, storage, misuse or abuse, accident or neglect, such as physical damage (cracks, scratches, etc.) to the surface of the product resulting from misuse; (b) contact with liquid, water, rain, extreme humidity or heavy perspiration, sand, dirt or the like, extreme heat, or food; (c) use of the Products or Accessories for commercial purposes or subjecting the Product or Accessory to abnormal usage or conditions; or (d) other acts which are not the fault of Motorola or SUNCORP, are excluded from coverage.

**Use of Non-Motorola branded Products and Accessories.** Defects or damage that result from the use of Non-Motorola branded or certified Products or Accessories or other peripheral equipment are excluded from coverage.

**Unauthorized Service or Modification.** Defects or damages resulting from service, testing, adjustment, installation, maintenance, alteration, or modification in any way by someone other than Motorola, SUNCORP or its authorized service centres, are excluded from coverage.

**Altered Products.** Products or Accessories with (a) serial numbers or date tags that have been removed, altered or obliterated; (b) broken seals or that show evidence of tampering; (c) mismatched board serial numbers; or (d) nonconforming or non-Motorola branded housings, or parts, are excluded from coverage.

**Communication Services.** Defects, damages, or the failure of Products or Accessories due to any communication service or signal you may subscribe to or use with the Products or Accessories is excluded from coverage.

### ***How to Obtain Warranty Service or Other Information?***

To obtain service or information, please call: (65) 68412668.

Email: support@alcom.com.sg

You will receive instructions on how to ship the Products or Accessories at your expense and risk, to a SUNCORP Authorized Repair Centre. To obtain service, you must include: (a) the Product or Accessory; (b) the original proof of purchase (receipt) which includes the date, place and seller of the Product; (c) if a warranty card was included in your box, a completed warranty card showing the serial number of the Product; (d) a written description of the problem; and, most importantly; (e) your address and telephone number.

## **Technical Information**

### ***How many telephones can I have?***

This product is intended to be connected as a single terminal to the telephone network, if more than one unit is connected they may not function correctly.

### **Connecting to a switchboard**

This product is intended for use within Singapore for connection to the public telephone network.

### **Recall**

You may need to use the recall function if you are connected to a switchboard or for certain network services. Contact your PABX supplier for further information.



### 13. Wall mounting

#### IMPORTANT

Before you wall-mount your CT2, check that you are not drilling into any hidden wiring or pipes. Before you drill, make sure the telephone line cable will reach the socket.

1. Drill two holes in the wall 9.2cm apart vertically using an 8mm drill bit.

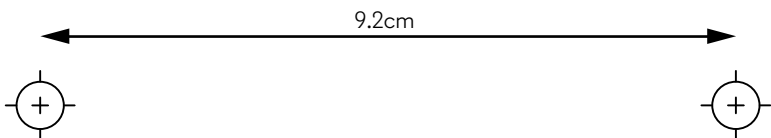
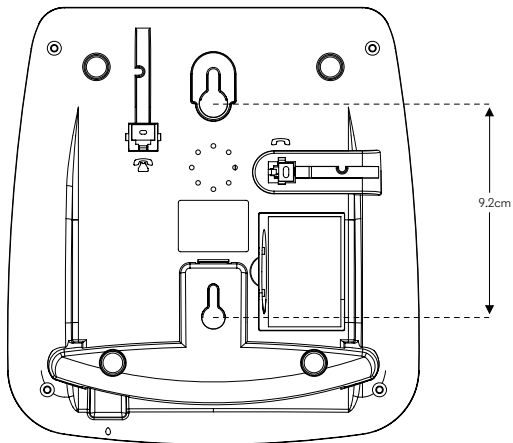

<This page has intentionally been left blank>

## Declaration of Conformity (DoC)

Suncorp declares that the following products:

Brandname: Motorola  
Type: CT2  
Descriptions: Corded telephone

to which this declaration related is in conformity with the essential requirements of the following directives of the Council of the European Communities:

- Low voltage Directive (2006/95/EC)
- EMC Directive (2004/108/EC)
- R&TTE Directive (1999/5/EC)

The products are compliant with the following standards:

Safety: EN60950-1:A12:2011  
EMC: EN55022:2010  
EN55024:2010

For and on behalf of Suncorp Technologies Limited,

Signature:



CW Cheung  
2013.07.09  
11:57:22 +08'00'

Printed name & Position: CW Cheung – Chief Technical Officer

Date: July 9, 2013

Place: 2/F, Shui On Centre, 6-8 Harbour Road, Hong Kong

Manufactured, distributed or sold by Suncorp Technologies Ltd., official licensee for this product. MOTOROLA and the Stylized M Logo are trademarks or registered trademarks of Motorola Trademark Holdings, LLC. and are used under license. All other trademarks are the property of their respective owners.  
© 2015 Motorola Mobility LLC. All rights reserved.

Version 2 (SG)

